

## Introduction

The single point remote immersion temperature thermostat incorporates a precision thermistor temperature sensor and provides a Form C relay output (NO/NC) with an adjustable setpoint. The sensor is encapsulated in a 6.35 mm (0.25") OD, 304 stainless steel probe and is available in various lengths. All probes provide excellent heat transfer, fast response and resist moisture penetration. Two enclosure styles are available.

## Before Installation

Read these instructions carefully before installing and commissioning the temperature thermostat. Failure to follow these instructions may result in product damage. Do not use in an explosive or hazardous environment, with combustible or flammable gases, as a safety or emergency stop device or in any other application where failure of the product could result in personal injury. **Take electrostatic discharge precautions during installation and do not exceed the device ratings.**

### Mounting (Probe)

**The TTLR sensor must be installed into a thermowell. Failure to use a thermowell will create leaks and could damage the sensor.** The TTLR is provided in two pieces, probe assembly and enclosure, which allows for easier installation. The TTLR probe assembly has 1/2" NPT threaded fitting for mounting to the thermowell. Install the thermowell as recommended in Figure 1. For complete thermowell installation instructions, please refer to installation instructions provided with the thermowell.

It is recommended to use heat conductive compound. Prior to installing the sensor inject a liberal amount into the thermowell and/or on the tip of the sensor. Slide the probe into thermowell until the fitting makes contact with the thermowell. Tighten slightly by hand by turning clockwise. Using a 23 mm (7/8") wrench, tighten the fitting into the thermowell until snug. To protect against overtightening and damaging the probe, the assembly is designed to allow the probe to slide inside the fitting. See Figure 2.

### Mounting (Enclosure A)

Mount the enclosure on a flat surface in close proximity to the area where the probe is inserted in the pipe. Secure the enclosure with (2) #10 x 25 mm (1") self tapping screws (not provided). Using a Phillips screwdriver, remove the (2) screws, as shown in Figure 3. Remove cover and set aside with screws for re-installing after wiring and set up.

Insert the probe assembly wire through the cable gland connector pulling about 150 mm (6") inside the enclosure. Tighten the cable gland connector using a 15 mm wrench until snug, as shown in Figure 4.

It is recommended in chilled water applications that the excess cable be coiled and hung so that it is lower than the pipe and the enclosure. This will prevent any condensation to run into the probe assembly or enclosure. See Figure 5.

A 21 mm (0.8125") hole provided for connection to a 12.77mm (0.5") EMT or cable gland style connector. Insert the EMT or cable gland connector through the hole and securely fasten using a locknut as shown in Figure 6. Make wire connections as per the "Wiring" illustrations on Page 3.

Once wiring and set up are complete, re-install cover and tighten the (2) screws using a Phillips screwdriver.

Figure 1

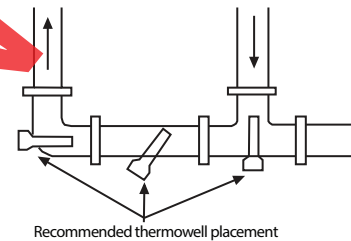

Figure 2

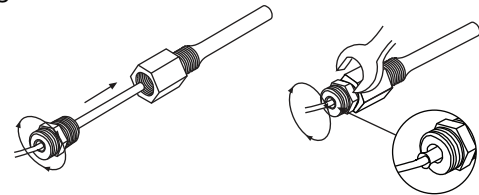

Figure 3

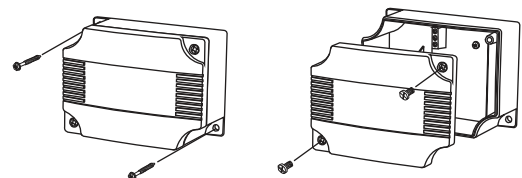

Figure 4

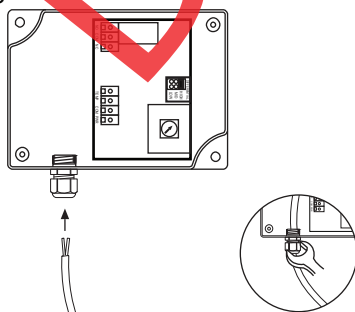

Figure 5

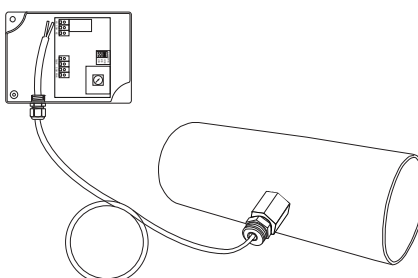
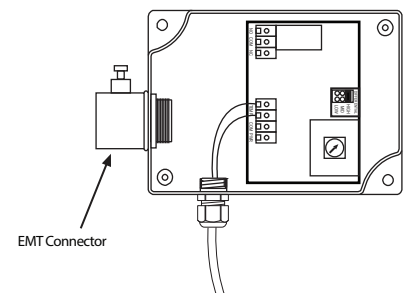
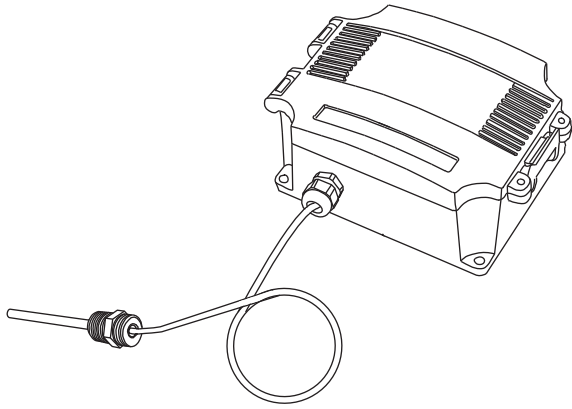

Figure 6





**Mounting (Enclosure D)**

Mount the enclosure on a flat surface in close proximity to the area where the probe inserted in the pipe. Secure the enclosure with (2) #10 x 25 mm (1") self tapping screws (not provided), as shown in Figure 7.

The enclosure has a hinged cover with latch. Open cover by pulling slightly on the latch on the right side of the enclosure. At the same time pulling on the cover, as shown in Figure 8.

Insert the probe assembly wire through the cable gland connector pulling about 150 mm (6") inside the enclosure. Tighten the cable gland connector using a 15 mm wrench until snug as shown in Figure 9.

It is recommended in chilled water applications that the excess cable be coiled and hung so that it is lower than the pipe and the enclosure. This will prevent any condensation to run into the probe assembly or enclosure. See Figure 10.

A 21 mm (0.8125") hole provided for connection to a 12.77mm (0.5") EMT or cable gland style connector. Insert the EMT or cable gland connector through the hole and securely fasten using a locknut as shown in Figure 11.

Make wire connections as per the "Wiring" illustrations on Page 3.

Swing door closed until securely latched. For added security, 2 screws are provided that may be installed in the integrated screw tabs. See Figure 12.

Figure 7

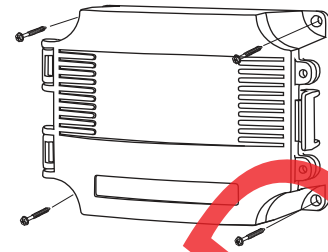

Figure 8

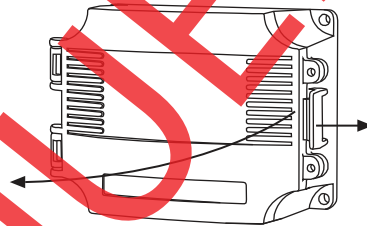

Figure 9

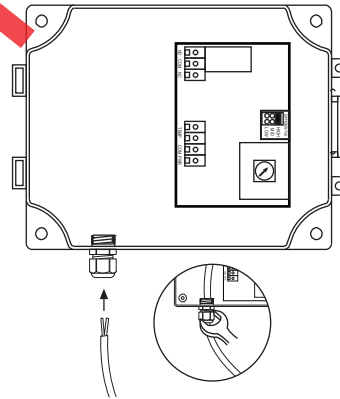

Figure 10

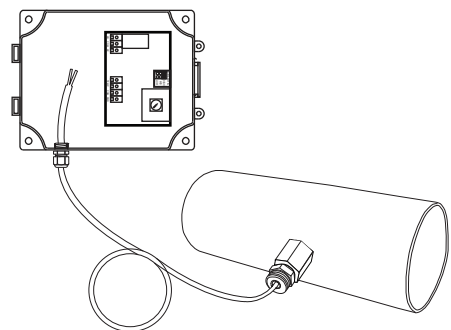

Figure 11

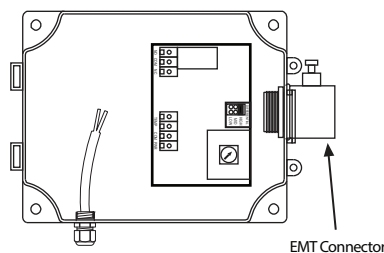
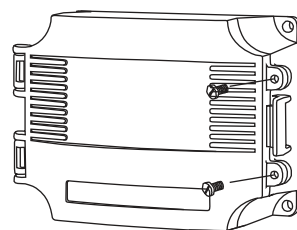
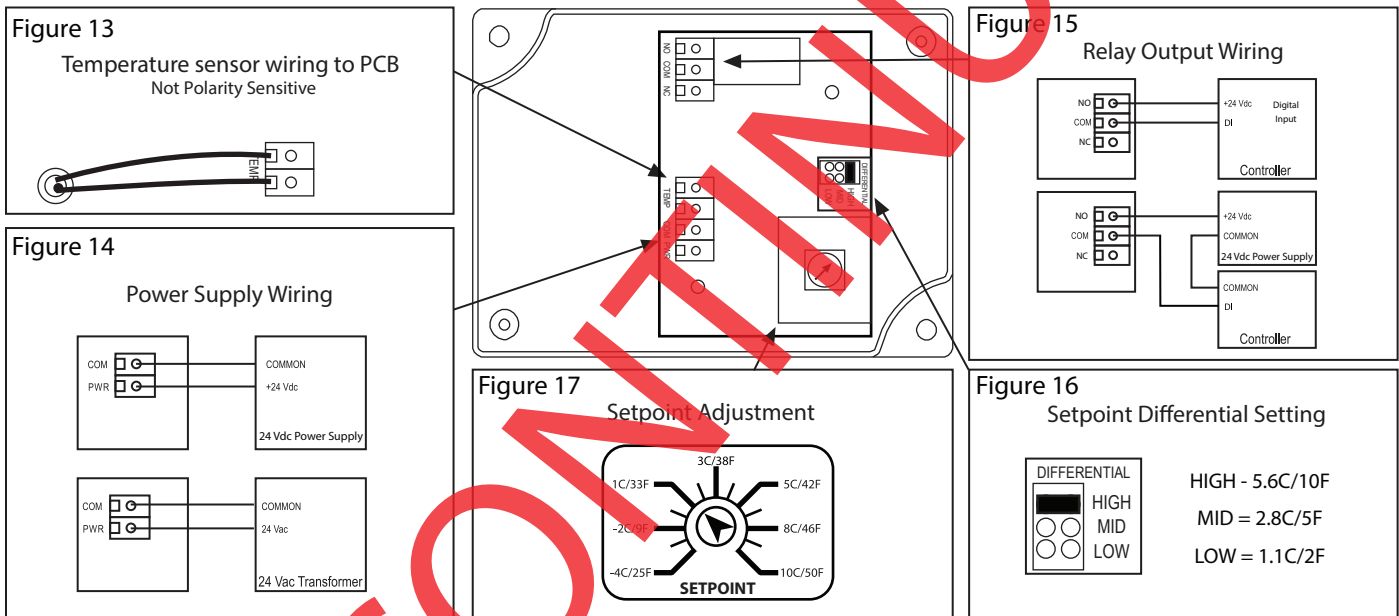

Figure 12



## Wiring

- Deactivate the 24 Vac/dc power supply until all connections are made to the device to prevent electrical shock or equipment damage.
- Use 14-22 AWG shielded wiring for all connections and do not locate the device wires in the same conduit with wiring used to supply inductive loads such as motors. Make all connections in accordance with national and local codes.
- Connect the temperature sensor to the terminals on the PCB marked TEMP. as shown in Figure 13 The temperature sensor is not polarity sensitive.
- Pull at least six inches of control wire into the enclosure, then complete the wiring connection according to the wire diagram for the applicable power supply as shown in Figure 14.
- Connect the DC positive or the AC voltage hot side to the PWR terminal. The supply common is connected to the COM terminal. See Figure 14.
- The relay has both Normally Open (NO) and Normally Closed (NC) contacts available. The relay output is available on the NO/COM/NC terminal. Make connections before applying power as shown in Figure 15.
- The setpoint differential has 3 jumper selectable settings (Low/Mid/High) Set jumper to desired differential as shown in Figure 16.
- To set the switching setpoint, turn the setpoint potentiometer to the desired temperature setting as shown in Figure 17.
- Once all connections settings are made and checked, power can be applied.



## Specification:

Power Supply	12 to 28 Vac/dc
Consumption	50 mA max
Relay Contacts	SPDT, Form C contacts (N.O. and N.C.) 5 Amps @ 30 Vdc/250 Vac resistive 1.5 Amps @ 30 Vdc/250 Vac inductive
Relay Action	Activates on temperature fall
Setpoint Operation	Single-turn knob-pot on pcb
Adjustable Setpoint	-4 to 10°C (25 to 50°F)
Setpoint Temperature Differential	Low/Mid/High jumper selectable 1.1/2.8/5.6 °C (2/5/10 °F)
Temperature Sensor	10K ohm curve matched precision thermistor
Sensor Accuracy	±0.2°C, 0 to 70°C (±0.36°F, 32 to 158°F)
Probe Sensing Range	-20 to 60°C (-4 to 140°F)
Probe Material	304 Series Stainless Steel

Probe Diameter	0.25" (6.35 mm) Diameter
Probe Lengths	50, 100, 150 or 200 mm (2", 4", 6" or 8")
Fitting Size	1/2" NPT
Fitting Material	Brass or Nylon
Wire Material	FT6 Plenum rated
Wire Length	1.524 m (5')
Operating Conditions	-10 to 50°C (14 to 122°F), 5 to 95% RH non-condensing
Storage Conditions	-30 to 70°C (-22 to 158°F), 5 to 95%RH, non-condensing
Enclosure	(A) ABS, UL94-5VB, IP61 (NEMA 2) (D)-ABS, UL94-5VB, IP65 (NEMA 4X)
Wiring Connections	Screw terminal block (14 to 22 AWG)

**Dimensions:**

**Enclosure A**

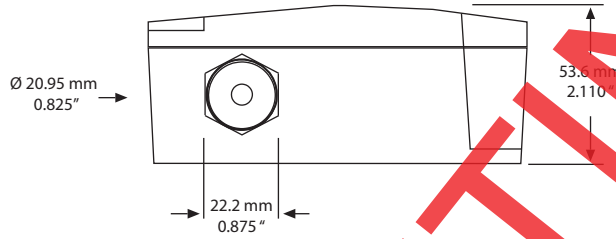
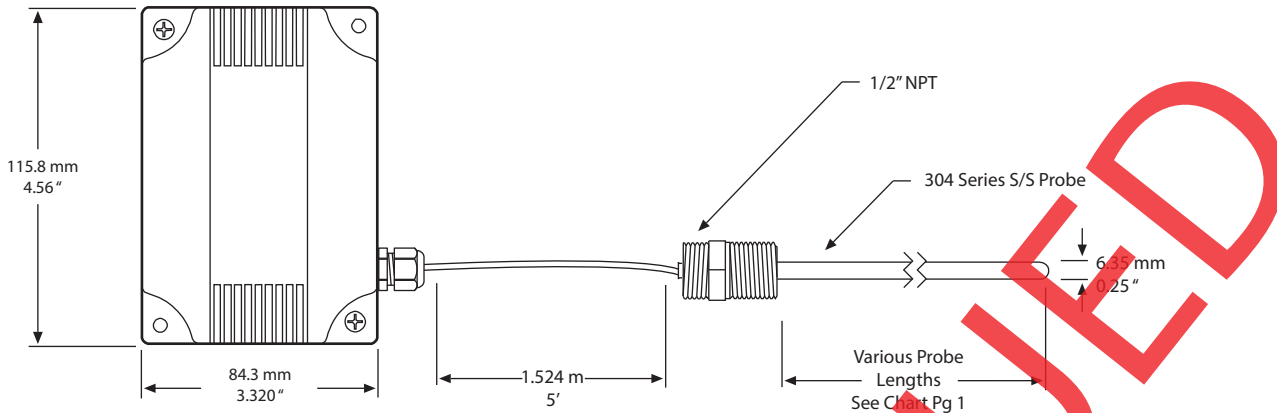

**Enclosure D**

