



GREYSTONE ENERGY SYSTEMS INC

IMMERSION TEMPERATURE SENSOR TE200C Series

The TE200C series single point immersion temperature sensor utilizes a precision sensor encapsulated in a 6.35 mm (0.25") OD, 304 series stainless steel probe and is available in various lengths (see ordering chart) All probes provide excellent heat transfer, fast response and resistance to moisture penetration. It is available with a variety of enclosures.

SPECIFICATION:

Sensor Type Thermistor or RTD
See Ordering Chart

Temperature Range.. -20 to 105 °C (-4 to 221 °F)
Higher Ranges Available
Contact Greystone

Wire Material..... PVC insulated, parallel bonded
(Type 2, 100 ohm platinum uses FT-4)

Probe Material 304 Series Stainless Steel

Probe Dimensions..... 0.25" (6.35 mm) Diameter

Enclosure Standard - ABS - UL94-5VB - IP61 (NEMA 2)
Round (E) - ABS - UL94-5VB - IP65 (NEMA 4X)
Metal (M) - Gal. Steel - IP50 (NEMA 1)
Weatherproof (W) - Cast Alum. IP64 (NEMA 3X)
*In order to maintain the published NEMA/IP ratings, properly rated conduit or cable gland adapters must be used.

Termination Pigtail 2 or 3 wire
Terminal block with (E) enclosure



PART NUMBER SELECTED

PRODUCT SELECTION INFORMATION:

MODEL	Product Description
TE200C	Immersion Temperature Sensor

CODE	Enclosure (ABS enclosure is standard)
	ABS enclosure, standard (no code required, leave blank)
E	Round ABS, w/gasketed cover
M	Metal utility box
W	Aluminum weatherproof box

CODE	Sensor
2	100 Ω Platinum, IEC 751, 385 Alpha, thin film
5	1801 Ω, NTC Thermistor, ±0.2 C
6	3000 Ω, NTC Thermistor, ±0.2 C
7	10,000 Ω, type 3, NTC Thermistor, ±0.2 C
8	2.252K Ω, NTC Thermistor, ±0.2 C
12	1000 Ω Platinum, IEC 751, 385 Alpha, thin film
13	1000 Ω Nickel, Class B, DIN 43760
14	10,000 Ω, type 3, NTC Thermistor, ±0.2 C c/w 11K shunt resistor
20	20,000 Ω, NTC Thermistor, ±0.2 C
24	10,000 Ω, type 2, NTC Thermistor, ±0.2 C

CODE	Probe Length
A2	50 mm (2")
B2	100 mm (4")
C2	150 mm (6")
D2	200 mm (8")
E2	300 mm (12")
F2	450 mm (18")

CODE	Fitting
A	Spring loaded 1/2" NPT
E	Non-spring loaded 1/2" NPT

Greystone Energy Systems, Inc. reserves the right to make design modifications without prior notice.

TYPICAL INSTALLATION:

For complete installation and wiring details, please refer to the product installation instructions.

NOTE: All immersion sensors require a thermowell (sold separately)

The immersion type probes are installed in the appropriate length thermowell for the pipe size. Thermal conductive compound should be added inside the thermowell to provide optimum thermal transfer.

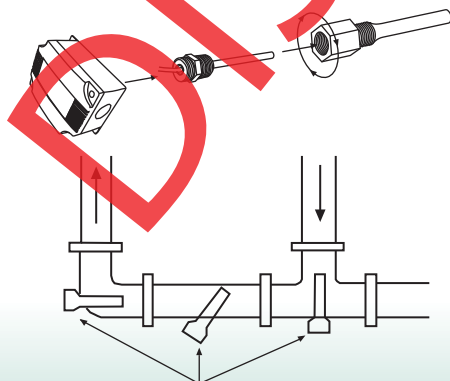

Thermowell placement in pipe

Dimensions:

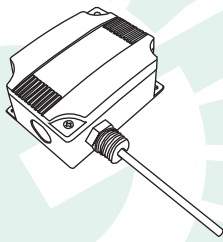

ABS Enclosure

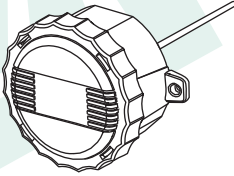
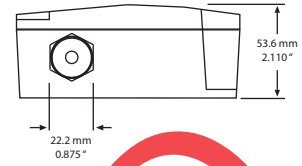
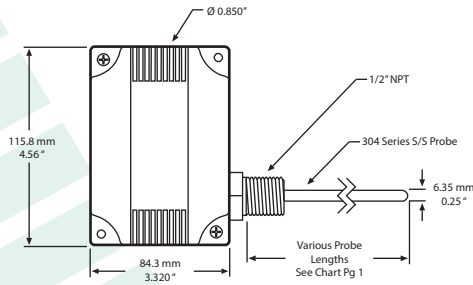

Round ABS Enclosure

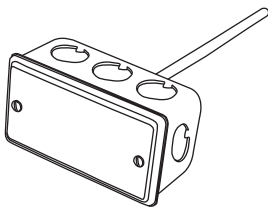
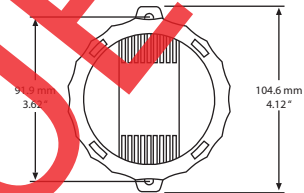
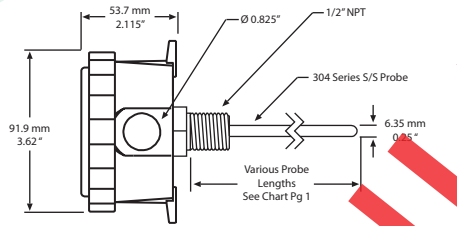

Metal Enclosure

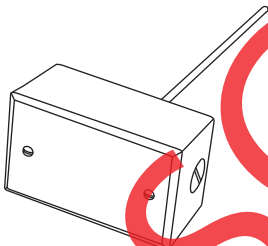
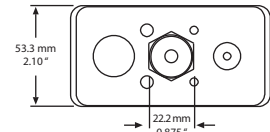
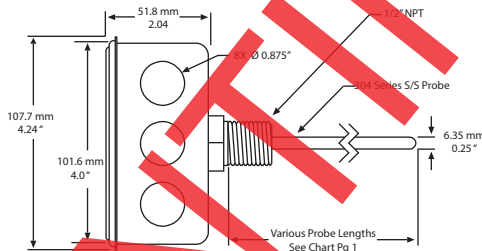

Weatherproof Enclosure

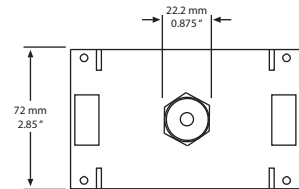
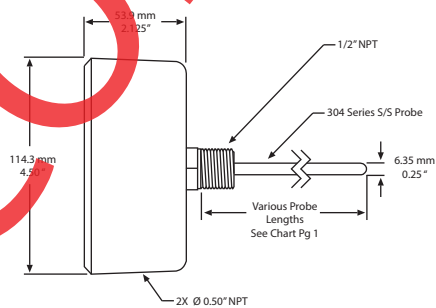

Greystone Energy Systems, Inc. reserves the right to make design modifications without prior notice.



GREYSTONE

ENERGY SYSTEMS INC

Greystone Energy Systems, Inc.
 150 English Drive, Moncton,
 New Brunswick, Canada E1E 4G7
 (506) 853-3057 Fax: (506) 853-6014
 North America: 1-800-561-5611
 e-mail: mail@greystoneenergy.com
 www.greystoneenergy.com

RoHS
 COMPLIANT



Greystone Energy Systems Inc. is one of North America's largest ISO registered manufacturers of HVAC/R sensors and transmitters for Building Automation Management Systems.

We have conscientiously established a worldwide reputation as an industry leader by maintaining leading-edge design technology, prompt technical support, and a commitment to on-time deliveries. We take pride in our Quality Management System which is ISO 9001 certified, assuring our customers of consistent product reliability.

GREYSTONE HAS AN **ISO 9001** REGISTERED QUALITY SYSTEM