





SPLIT-CORE CURRENT SENSOR





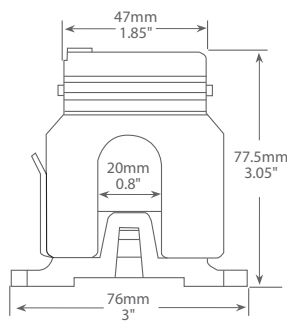

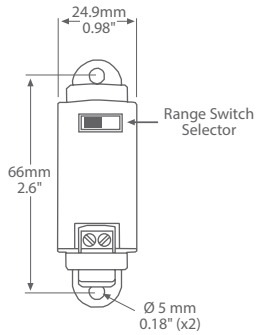

SC-651

PRODUCT DESCRIPTION

The SC-651 Series current sensors monitor line current for electrical loads such as pumps, conveyors, machine tools, or fans and output a 0-10 Vdc signal to represent the load current.

The SC-651 require no external power as they are totally powered by induction from the AC line being monitored.

The sensors are typically used to monitor motor operation and can be used to determine motor failure, belt loss, machine feed rates or tool wear.

TYPICAL INSTALLATION

For complete installation and wiring details, please refer to the product installation instructions.

The SC-651 series must be mounted in an electrical enclosure and has an removable integral mounting tab to allow either screw mount to a surface or spring mount to a DIN rail.

The SC-651 series has a 2 wire connection to the Building Automation System.

SPECIFICATIONS

MEASUREMENT RANGE	SC-651-R1: 0-20/40/60 Amps SC-651-R2: 0-50/100/150 Amps SC-651-200: 0-200 Amps
MAXIMUM INPUT CURRENT	SC-651-R1: 100 Amps continuous SC-651-R2: 150 Amps continuous SC-651-200: 225 Amps continuous
ACCURACY	SC-651-R1/R2: ±2% FSO (5-100% of range) SC-651-200: ±1% FSO (5-100% of range)
SIGNAL OUTPUT	0-10 Vdc
SENSOR POWER	Self-powered
INSULATION CLASS	600 Vac, insulated conductors
FREQUENCY	50/60 Hz
RESPONSE TIME	200 mS typical, 0-90%
OUTPUT LOAD	1 MΩ typical
LOADING ERROR	Add 0.5% error with 100KΩ
OPERATING TEMPERATURE	-15 to 60°C (5 to 140°F)
OPERATING HUMIDITY	5 to 90 %RH non-condensing
TERMINAL BLOCK	14 to 22 AWG
DIMENSIONS	76mm W x 79mm H x 24.9mm D (3.0" x 3.1" x 0.98")
SENSOR APERTURE	20.3mm (0.8")
ENCLOSURE MATERIAL	ABS/PC, UL94-V0
AGENCY APPROVALS	cULus listed

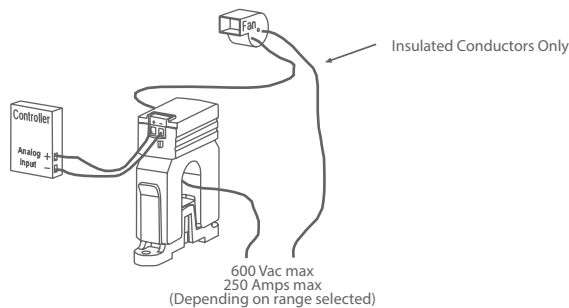

ORDERING

PRODUCT	SC-651 Split-Core Current Sensor, 0-10 Vdc Output									
SENSING RANGE	<table border="0"> <tr> <td>R1</td> <td>0-20/40/60 Amps - switch selectable</td> <td>100 Amps Continuous</td> </tr> <tr> <td>R2</td> <td>0-50/100/150 Amps - switch selectable</td> <td>150 Amps Continuous</td> </tr> <tr> <td>200</td> <td>0-200 Amps</td> <td>225 Amps Continuous</td> </tr> </table>	R1	0-20/40/60 Amps - switch selectable	100 Amps Continuous	R2	0-50/100/150 Amps - switch selectable	150 Amps Continuous	200	0-200 Amps	225 Amps Continuous
R1	0-20/40/60 Amps - switch selectable	100 Amps Continuous								
R2	0-50/100/150 Amps - switch selectable	150 Amps Continuous								
200	0-200 Amps	225 Amps Continuous								

PART NUMBER

SC-651

NOTE: Greystone Energy Systems, Inc. reserves the right to make design modifications without prior notice.



Greystone Energy Systems, Inc.
150 English Drive, Moncton,
New Brunswick, Canada E1E 4G7

Ph: +1 (506) 853-3057 Fax: +1 (506) 853-6014
North America: 1-800-561-5611
E-mail: mail@greystoneenergy.com