



**GREYSTONE**  
ENERGY SYSTEMS INC

## **B5C GAS TRANSMITTER**



## **INSTALLATION OPERATION AND MAINTENANCE MANUAL**

Greystone Energy Systems Inc.  
PHONE: +1 (506) 853-3057 Web: [www.greystoneenergy.com](http://www.greystoneenergy.com)

Copyright © Greystone Energy Systems, Inc. All Rights Reserved

**FACTORY CALIBRATION AND DEFAULT SETTINGS .....2**

**READ BEFORE OPERATING .....3**

**1. SPECIFICATIONS.....3**

1.1 ELECTRICAL/MECHANICAL SPECIFICATIONS .....3

**2. INSTALLATION .....5**

2.1 ENCLOSURES PHYSICAL DIMENSIONS.....5

2.2 TERMINALS.....5

    2.2.1 *Wire and Cable*.....6

    2.2.2 *RS-485 Terminator*.....7

    2.2.3 *RS-485 Driver Replacement*.....7

    2.2.4 *Relays Output*.....7

    2.2.5 *Note for B5C:*.....8

    2.2.6 *Certification:*.....8

**3. FUNCTION AND CONFIGURATION .....9**

3.1 INDICATORS.....9

    3.1.1 *RS485-TX/RX:*.....9

    3.1.2 *Relay 1-3 LED:*.....9

3.2 TOOL FUNCTION .....10

    3.2.1 *Enter Main Menu*.....10

    3.2.2 *Hush Buzzer and Relay*.....10

    3.2.3 *Reset Latched/Hushed*.....10

    3.2.4 *Reset MENU Password*.....10

    3.2.5 *Exit Tool Mode*.....10

3.3 MAIN MENU TREE .....11

3.4 MENU “1\_SYSTEM SETUP” .....12

    3.4.1 *System Settings* .....12

3.5 MENU “2\_ZERO CAL” .....15

    3.5.1 *Equipment Required*.....15

    3.5.2 *Zeroing Calibration Procedure*.....15

3.6 MENU “3\_SPAN CAL” .....16

3.7 MENU “4\_OUT TEST”.....17

3.8 MENU “5\_VIEW SETTING” .....18

3.9 MENU “6\_ALARM SETUP”.....19

3.10 MENU “7\_RELAY STYLE”.....20

3.11 MENU “8\_BUZZER STYLE”.....21

3.12 MENU “A\_ALL DISABLE” .....21

3.13 MENU “B\_SIMULATION” .....21

3.14 MENU “C\_SITE SERVICE” AND “D\_FACTROY SET”.....21

**4. BACNET PIC STATEMENT SUPPORTED BY B5C .....21**

4.1 SMART SENSOR ASSEMBLY REPLACEMENT.....21

    4.1.1 *Disassembling* .....21

    4.1.2 *Replacement Procedure*.....22

    4.1.3 *Replacement Parts*.....23

    4.1.4 *Accessories*.....23

**5. TROUBLESHOOTING .....24**

## Factory Calibration and Default Settings

This B5C CO transmitter has been calibrated in our facilities according to the manufacturer's procedures.

- SPAN:
  - B5C-CO-250P: 0 – 250 ppm CO
  - B5C-CO-1000P: 0 – 1000 ppm CO
- CAL GAS:
  - 100 ppm CO balanced with air

The B5C CO transmitter default settings:

- Password: 4321
- Address: 126
- Protocol: BACnet /MSTP Master at 38.4kbps baud rate
- BACnet UTC Offset: 300
- Daylight Saving: Yes
- Device Object ID: 4005
- LCD Backlight: Auto

- Alarm Settings:

Alarm#	Input	On Concentration	Off Concentration	Output Trigger
Alarm1	Instant	30ppm	25ppm	Relay1
Alarm2	Instant	50ppm	40ppm	Relay1, Relay2
Alarm3	Instant	100ppm	95ppm	Relay1,2,3, Buzzer1
Alarm4	Fault	---	---	Relay3, Buzzer3
Alarm5/6/7/8	Disabled			

- Relay & Buzzer Settings:

Relay#	Normally Energized	Latch	On Delay	Off Delay	Style
Relay1	NO	NO	5 seconds	5 seconds	Normal Relay
Relay2	NO	NO	5 seconds	5 seconds	Normal Relay
Relay3	NO	NO	5 seconds	5 seconds	Normal Relay
Buzzer1/2/3	Disabled				

\*Note: Each setting can be modified in B5C Menu

\*Note: For BACnet settings, see 85950-103-000 Rx (B5 PIC Statement)

\*Note: Per UL standard 2075, this B5C sensitivity limits are superior to the standard sensitivity requirements defined in UL2075.

## READ BEFORE OPERATING

All individuals who have or will have the responsibility of using, maintaining, or servicing this product must carefully read this manual. The product will perform as designed only if it is used, maintained, and serviced in accordance with the manufacturer's instructions.

The B5C is a state-of-the-art transmitter that can operate as an independent, stand-alone system or as part of an integrated system. Setup procedures are simplified with user friendly push buttons and LCD menus.

The B5C is the Q5C gas transmitter with BACnet® MS/TP master protocol. Therefore, the B5C does not support the 4-20mA and VDC analog output.

BACnet MS/TP protocol is a peer-to-peer, multiple master protocol based on token passing. Only master nodes are allowed to send and receive tokens on the MSTP network. Passive slave nodes on the other hand may only transmit data frames on the network in response to a request from a master node. Passing the token represents overhead in the sense that the messages used for managing the token do not carry data that is useful to automation or monitoring.

The B5C can be set to be a Master Node or a Slave Node in the field. Factory default is master node.

## 1. Specifications

### 1.1 Electrical/Mechanical Specifications

<b>Input Power:</b>	24VDC nominal, range 18 to 30VDC, 0.3A DC Total Max. 24VAC nominal, range 18 to 24VAC, 0.3A AC Total Max.
<b>Fuse:</b>	F2 on Main Board: Polyswitch 750mA Polyswitch device resets after the fault is cleared and power to the circuit is removed.
<b>Sensor:</b>	Electrochemical Sensor. Real-time Supervision test and diagnose with end-of-life notification. When the sensor has reached the end of its life, fault "SENSOR FAIL" will be reported and displayed on the LCD
<b>Sampling:</b>	Diffusion or Pump-through

<b>Panel Indicators:</b>	5 Status LED's <ul style="list-style-type: none"><li>• RS-485 TX Status (Green)</li><li>• RS-485 RX Status (Green)</li><li>• Relay1 Status (Red)</li><li>• Relay2 Status (Red)</li><li>• Relay2 Status (Red)</li></ul>
<b>Display:</b>	LCD graphic display c/w backlight
<b>Keypad:</b>	3 capacitive touch sensing Keys: F1, F2, F3
<b>Relays:</b>	3 Relays SPDT, Dry contacts <ul style="list-style-type: none"><li>• 1.0A maximum at 30 VDC (resistive load)</li><li>• 0.3A maximum at 125VAC (resistive load)</li></ul>
<b>Buzzer:</b>	55 dB at 10 feet, 2700 Hz Buzzer 1, 2, 3: Programmable tone Tone: chirp once / chirp twice / 50% duty cycle / constant ON
<b>Output Signal:</b>	BACnet® MS/TP master /slave protocol
<b>Enclosure Rating:</b>	IP 66 & NEMA 4, 4X, 12 & 13
<b>Operating Temperature:</b>	-20°C to 40°C
<b>Ambient Humidity:</b>	5% to 95% RH (non-condensing)
<b>Storage Temperature:</b>	0°C to 20°C
<b>Size:</b>	150mm X 90mm X 65mm
<b>Weight:</b>	Less than 0.5lbs

## 2. Installation

### 2.1 Enclosures Physical Dimensions

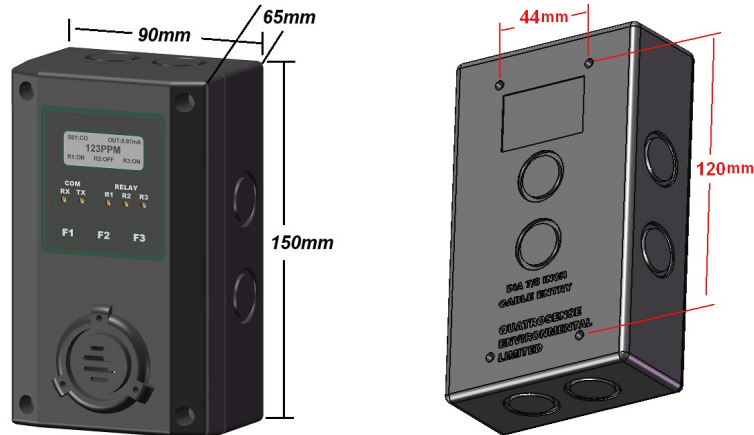

The enclosure is a NEMA 4 rated enclosure and can be wall mounted with 4 screws. To maintain the NEMA rating, it is important that the conduit opening is sealed upon installation.

### 2.2 Location

The transmitter should be mounted where the gas to be measured is most likely to be present. This location will be dependent on the source of the target gas and whether that gas is lighter or heavier than air. Air circulation and mixture should also be taken into account.

CO gas is lighter than regular air, it can be mounted on the walls at least a couple of feet below the height of the ceiling. As the transmitter has a digital read-out, placing it at about eye level is strong recommended.

The location should be accessible for the purposes of routine re-calibration and periodic sensor replacement. Sufficient room should be left to allow the enclosure cover to be removed and the connection of the calibration adapter to the sensor chamber. For sensor element replacement there will need to be enough room to remove enclosure cover and the sensor board assembly.

**NOTE: The transmitter can also be installed in limited outdoor environment - An ambient air environment that is not climate controlled and is not in direct contact with the elements of nature, such as wind, rain, sleet or snow. Examples of limited outdoor environments include parking garages, construction complexes, sports venues, boats and recreational vehicles.**

**NOTE: Avoid mounting the transmitter near 600 VAC switchgear and other sources of radio frequency and/or electromagnetic interference. While RFI/EMI**

protection is built in to the transmitter, excessive levels of interference may cause instability in the output signal.

### 2.3 Terminals

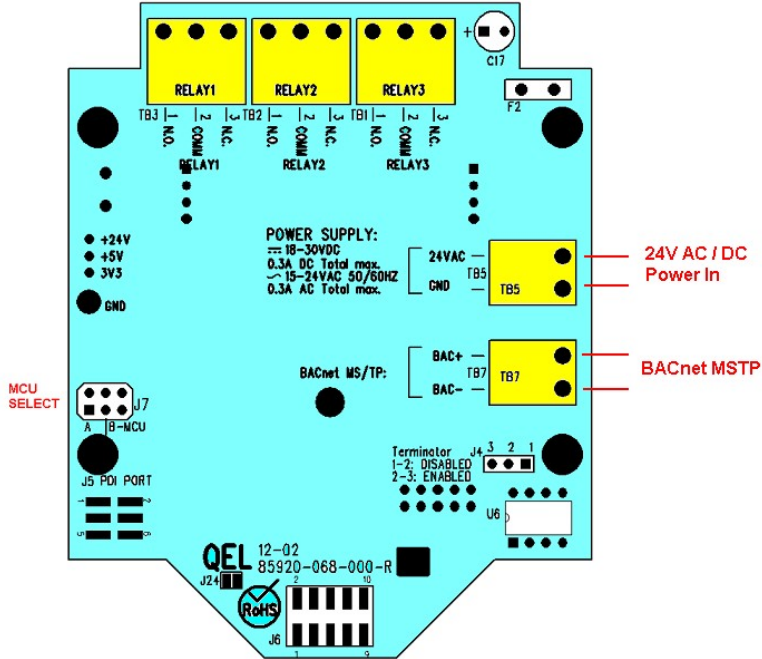

B5C Terminals

#### 2.3.1 Wire and Cable

Terminal blocks TB1 to TB7 accept 12 AWG to 24 AWG wire. Use 16 AWG or 18 AWG wire for the power supply in long wiring runs, which can be up to 1km (1,000 meters) long.

We recommend using BELDEN 9841 for communications. This wire has 120 ohm input impedance, which will eliminate RS-485 communication problems.

### 2.3.2 RS-485 Terminator

The terminator on each end of the RS485 run is designed to match the electrical impedance characteristic of the twisted pair wire, and will prevent signal echoes from corrupting the data on the line. The terminator should be enabled on BOTH ends of the RS485 run. Short and medium length Modbus/485 runs can operate without the terminating resistor. Longer runs may require the terminating resistors. But adding terminator dramatically increases power consumption.

#### **Factory default setting is disabled terminator.**

The B5C supplies this resistor on the main board, and it is chosen using a jumper at J4.

- J4 1-2: Terminator Disabled / OFF (default)
- J4 2-3: Terminator Enabled / ON

### 2.3.3 RS-485 Driver Replacement

RS-485 lines in heavy industrial environments are sometimes subjected to magnetic disturbances causing sufficient inducted power surges to damage the driver integrated circuit (IC). This IC (U6) has a socket on the circuit card for ease of replacement in the field.

### 2.3.4 Relays Output

The B5C has three onboard programmable Single-Pole Double-Throw (SPDT) relays. These relays can be used to control other equipment, such as fans, lights, horns, etc. eliminating the need for a separate controller.

Three terminal blocks (TB1, TB2 and TB3) are located on the main board. Each relay can be programmed individually.

Switching capability of each relay is:

- 1.0 A maximum resistive load at 30 VDC
- 0.3A maximum resistive load at 125VAC



### 2.3.5 Note for B5C:

The B5C supports BACnet MS/TP protocol and can be networked to form a BACnet MS/TP network.

The B5C default baud rate is 38400bps.

Each B5C on the MS/TP network must have a unique BACnet MAC address and unique Device Instance Number (Object ID).

- B5C valid MAC addresses are 0-127 for master node, 0-254 for slave node.
- B5C default MAC address is 126.
- Default Device Instance Number (Object ID) is 4005.

The B5C power supply and RS-485 connection are similar to the Q5C. The B5C doesn't have terminal blocks TB4 and TB6.

Avoid running communication wires or sensor input wires next to AC power wires or the relay output wires. These can be sources of noise that can affect signal quality.

**The B5C has a half wave rectifier on board. You will damage devices if you mix half wave and full wave rectifiers on the same AC source. Use extreme caution when sharing a common AC source. Sharing a common DC source is less problematic.**

When the B5C input power is AC, the 24VAC can be either grounded or non-grounded. Polarization is very important when the B5C is connected to a network. Make sure the Neutral is connected to the GND of TB5.

### 2.3.6 Certification:

The Q5/B5 series have been certified to the following Standard:

*Safety requirement for Electrical Equipment for Measurement, Control, and Laboratory Use- Part 1: General Requirements CAN/CSA-22.2 No. 61010-1 Third Edition, Dated May 11, 2012;*  
*And*

*Safety Requirements for Electrical Equipment for measurement, Control, and Laboratory Use- Part 1: General Requirements UL 61010-1 Third Edition, Dated May 11, 2012.*

*Installation must be in accordance with ANSI/NFPA 70, National Electrical Code (NEC); the*

*Canadian Electrical Code (CEC), Part I, CSA C22.1, and CSA C22.2 No. 0; and the Manufacturers' installation instructions*

**The Q5C/B5C Carbon Monoxide transmitters are certified to UL2075 Life Safety Standards. Project#: G102400708, G102389154. For details, contact GES.**

### 3. Function and Configuration

#### 3.1 Indicators

The indicators consist of five LED's – two to indicate RS-485 digital communication, three to indicate the status of relays 1-3.



##### 3.1.1 RS485-TX/RX:

When the B5C is connected to a controller system via RS-485, the traffic of the communication can be monitored visually through the two RS-485 indicators. One is RX LED, which indicates the data stream received in from the controller. The other is TX LED, which indicates the data stream out of the B5C.

**Note: If the TX LED or the RX LED is always ON, is indicative of a communication problem. See Troubleshooting for RS-485.**

##### 3.1.2 Relay 1-3 LED:

Indicate the status of each relay. When the relay is actuated/closed, the relay LED is ON. When the relay is de-actuated/open, the relay LED is OFF.

**Note: If you set the relay to be Normally Energized (Fail Safe), the relay LED will turn ON at non-alarm state and turn OFF at alarm state, because the LED reflects the relay coil status.**

### 3.2 Tool Function

Press key [F3] to enter tool functions that might be used frequently in the field.

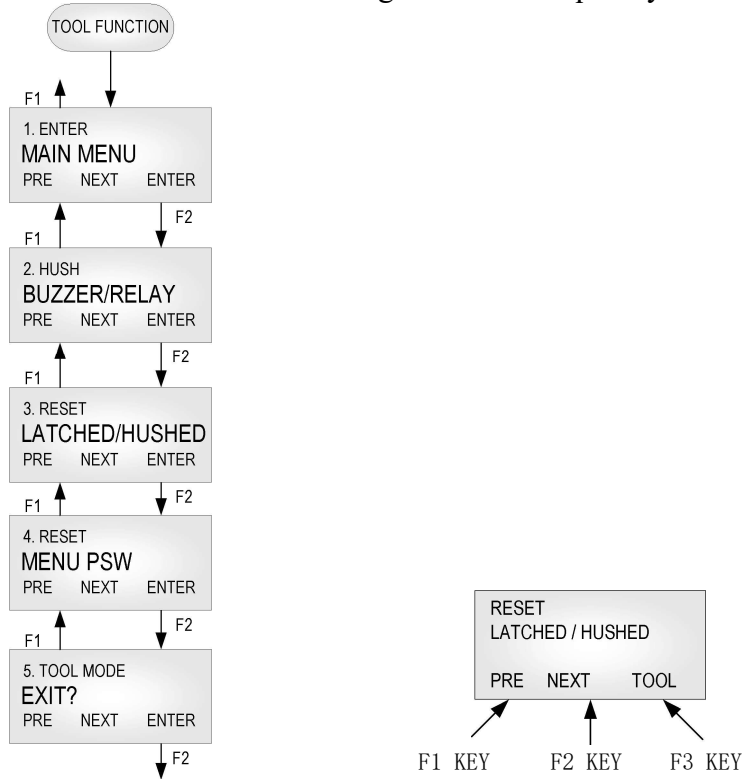

#### 3.2.1 Enter Main Menu

Press key [F1] to browse previous item of the current menu.

Press key [F2] to browse next item of the current menu.

Press key [F3] to enter the main menu for more configuration and settings.

#### 3.2.2 Hush Buzzer and Relay

Press key [F3] to silence the buzzer and buzzer-style relays.

#### 3.2.3 Reset Latched/Hushed

To acknowledge a latched condition or a hushed condition, press key [F3] to reset latched relays and hushed buzzer for which the alarm condition has been removed. If the alarm condition (e.g. high gas concentration) is still present the relay(s) will not reset.

#### 3.2.4 Reset MENU Password

If you forgot the main menu password, you can reset the menu password to default password “4321” by entering a correct active code. For the active code, contact GES.

#### 3.2.5 Exit Tool Mode

Press key [F3] to return to monitoring mode.

### 3.3 Main Menu Tree

The main menu is password protected. Once the password is accepted, you are allowed into the main menu tree.

**Factory default password is 4321.**

**Note: While in the menu tree, all normal monitoring operations stop. The alarm status does not change.**

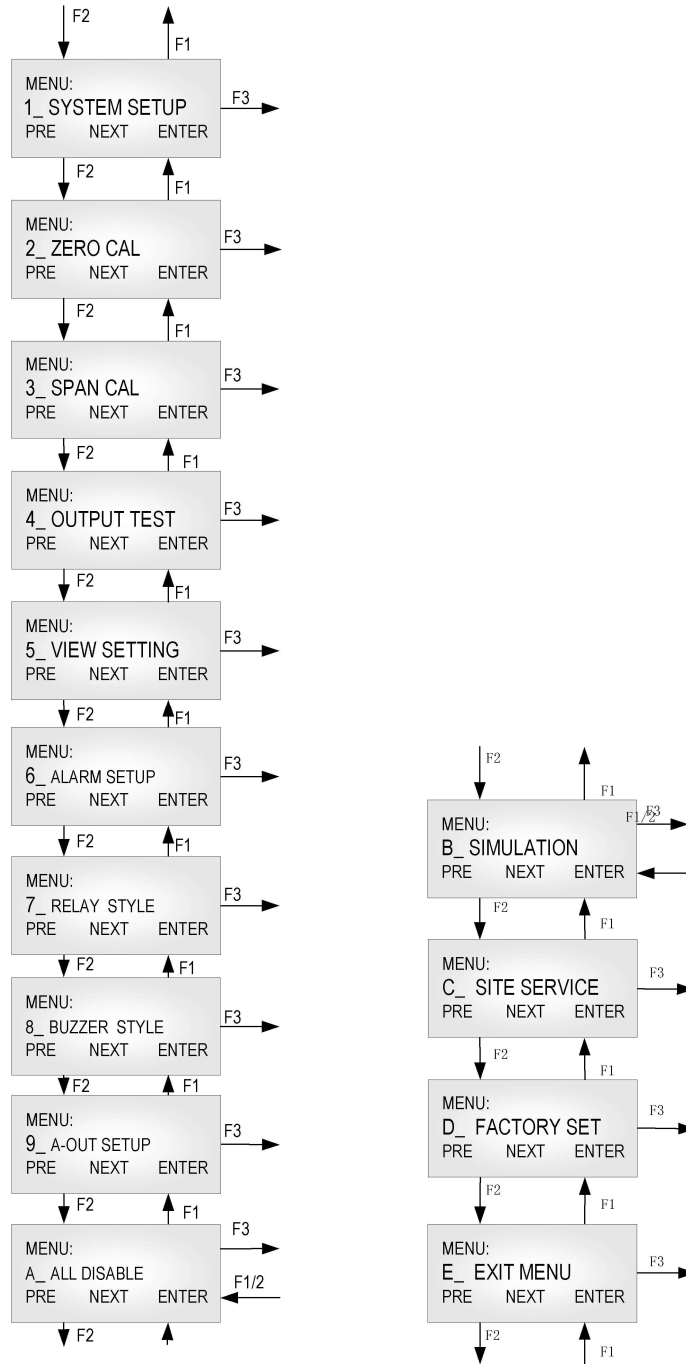

### 3.4 Menu “1\_SYSTEM SETUP”

The system setup subdivision contains general settings for monitor operations, communications and 4-20mA calibrations.

#### 3.4.1 System Settings

<b>Password:</b>	Default password is 4321.
<b>MAC Address:</b>	The B5C RS-485 address can be defined from 0 to 255. B5C default address is 126.
<b>Object ID:</b>	BACnet Device Instance Number. Default is 4005.
<b>Baud rate:</b>	Define baud rate for RS-485 communication with BACnet protocol.  B5C default baud rate is 38400 bps.
<b>Scroll Rate:</b>	In normal operation, the sensor and relay status information scrolls automatically. Set the number of seconds for each item to be displayed. Default value is 3 seconds.
<b>Backlight:</b>	The LCD backlight can be set to Always Off, Always On and Auto Power Saving mode. In Auto Power Saving mode, the backlight will turn on for 10 seconds after any key has been pressed. Default setting is Auto.
<b>UTC Offset</b>	The B5C supports the execution of the TimeSynchronization service and UTCTimeSynchronization service. It indicates the number of minutes ( - 780 to +780) offset between local standard time and Universal Time Coordinated. Default is +300 (US & Canada Eastern Time).
<b>Daylight Saving</b>	It indicates whether daylight saving time is in effect (Enabled) or not (Disabled) at the B5C location in UTCTimeSynchronization service.  Default is Enabled.
<b>New Password:</b>	The new password can be any combination of up to four digits. Default password is 4321.  <b>Warning: Be sure that you record the new password in a safe and secure location!</b>
<b>Protocol:</b>	The B5C supports BACnet MS/TP master or slave protocol. Default is MS/TP master.

<p><b>Display Mode:</b></p>	<ul style="list-style-type: none"> <li>• Display Instant: displays instantaneous gas concentration</li> <li>• Display Average:             <ul style="list-style-type: none"> <li>○ Displays STEL (15min average reading)</li> <li>○ Displays TWA (8 hour average reading)</li> <li>○ Displays daily peak</li> </ul> </li> <li>• Display Alarm: displays alarm 1-8 status</li> <li>• Display Relay: displays relay 1-3 status</li> <li>• Display Buzzer: displays buzzer 1-3 status</li> <li>• Display A-Out mA: displays current 4-20mA output</li> <li>• Display A-Out VDC: displays current VDC output</li> <li>• Display Clock: displays real time clock (Default is no clock display)</li> </ul> <p>If there is nothing to display, the unit will display “Running...”</p>
<p><b>Auto Zero:</b></p>	<p>When AutoZero is set to ON, the unit will gather the lowest reading in 7-day period and set the unit into Zeroing Calibration mode so that the lowest reading goes to zero. When AutoZero is set to OFF, the unit will not adjust its own zero and work off the last manual or factory calibration.</p> <p>Default value is OFF.</p> <p><b>NOTE: AutoZero works best in situations where the building will purge at night (or over a weekend) to a zero concentration of target gas.</b></p>
<p><b>Key Beeper:</b></p>	<p>ON: Beeping when keypad is touched</p> <p>OFF: No beeping when keypad is touched</p>
<p><b>Restore Default:</b></p>	<p><b>Note: Don’t do this if you don’t have calibration gas and precision reference instrumentation to calibrate the unit.</b></p> <p>To load defaults to factory settings, to restore the unit to correct operation.</p> <p>The settings below will be restored to default values:</p> <p>-Password, -Baud rate, -Scroll rate, -Backlight, -Display mode, -Key beeper, -LCD contrast, <b>-Gas type on the Sensor Board</b>, -Alarm settings, -Relay/Buzzer settings, and 4-20mA/1-5VDC settings.</p> <p>Zero and span calibrations are needed.</p>
<p><b>ADJ Clock:</b></p>	<p>Adjust real time clock.</p>

	<p>The B5C supports the execution of the TimeSynchronization service and UTCTimeSynchronization service. The clock can be adjusted remotely.</p>
<p><b>ADJ Contrast:</b></p>	<p>Adjust the LCD contrast. Valid values are between 10 (light) and 50 (dark). Default is 21.</p>
<p><b>Check Battery</b></p>	<p>The sensor board is equipped with a coin battery. This setting will enable or disable the B5C to check the battery voltage and beep for a low battery level.  Default is ON.</p>
<p><b>Output Priority:</b></p>	<p>Alarm output (BV) present_value and relay output (BO) present_value support command prioritization. The B5C has priority #12 as default.  The lower the priority number the more critical the nature of the output. Priority #1 is considered the highest priority. Priority #16 is the lowest priority.</p>

### 3.5 Menu “2\_ZERO CAL”

The B5C is calibrated using a two-point calibration process. First, use a “Zero Gas”, then use a “CAL Gas” containing a known concentration of a standard reference gas, to set the second point of reference.

#### 3.5.1 Equipment Required

- A cylinder of Zero Gas, (clean air or nitrogen).
- A cylinder of Cal Gas
- Flow Limiting Regulator(s) **0.2 to 1.0 lpm**
- Tubing

#### 3.5.2 Zeroing Calibration Procedure

- “2\_ZERO CAL:”

2\_ZERO CAL

- Press key [F3] and the device will show the calibration notice and then ask if you want to continue. The middle line will display the current concentration.

CONTINUE?  
XXPPM

- Apply the Zero Gas.
- Wait for about 3 minutes or until the reading is stable.
- Press key [F3] to confirm Zeroing Cal.
- When the device is in Zeroing CAL, it will take 3 seconds to 20 seconds to complete.
- When the zeroing CAL operation is over, the device will display “Accepted” and return to “2\_ZERO CAL”.
- Make sure there is no Cal Error displayed. If Cal Error is reported, repeat the procedures above. If the Cal Error is still showed up, the sensor may be expired.
- Remove the gas.
- Exit the menu to Monitoring Mode.



### 3.6 Menu “3\_SPAN CAL”

- “3\_ SPAN CAL”

3_ SPAN CAL
-------------

- Press key [F3] and the device will ask for the CAL GAS, input the concentration of the calibration gas.

CAL GAS: >                   XXX
-------------------------------------

- Press key [F3] and the device will show the calibration notice and then show the flow rate for the span calibration. Press any key to continue, and then the device will ask you if you want to continue. The middle line will display the current concentration.

CONTINUE? XXPPM
--------------------

- Apply the calibration gas.
- Wait for about 3 minutes or until the reading is stable.
- Press key [F3] to confirm SPAN CAL.
- When the device is in span cal, it will take 10 seconds to 1 minute to complete.
- When the span cal operation is over, the device will display “Accepted” and return to “3\_ SPAN CAL”.
- Make sure there is no Cal Error displayed. If Cal Error is reported, repeat the procedures above. If the Cal Error is still showed up, the sensor maybe expired.
- Remove the gas.
- Exit menu to Monitoring Mode.

### 3.7 Menu “4\_OUT TEST”

During system installation and testing, it may be necessary to force relays and buzzers on and off.

The Relay Testing feature allows the user to force the actuation of each relay. This function forces an Actuate vs. De-actuate action, not an energized vs. non-energized action. Therefore the user must be aware of these relays, which have been defined as normally energized or not normally energized.

The 4mA (1VDC/2VDC) and 20mA (5VDC/10VDC) outputs can be tested too.

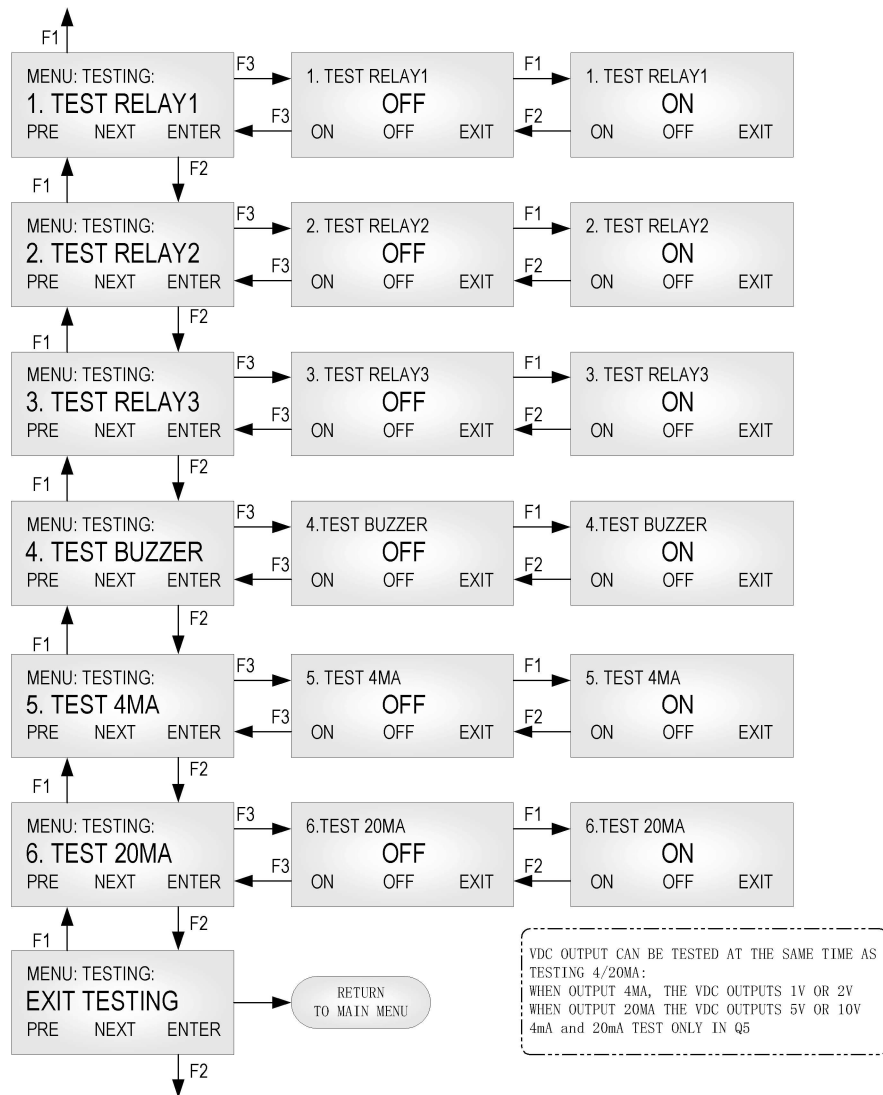

### 3.8 Menu "5\_VIEW SETTING"

This function is to verify the settings for the alarms, relays, buzzers and analog outputs.

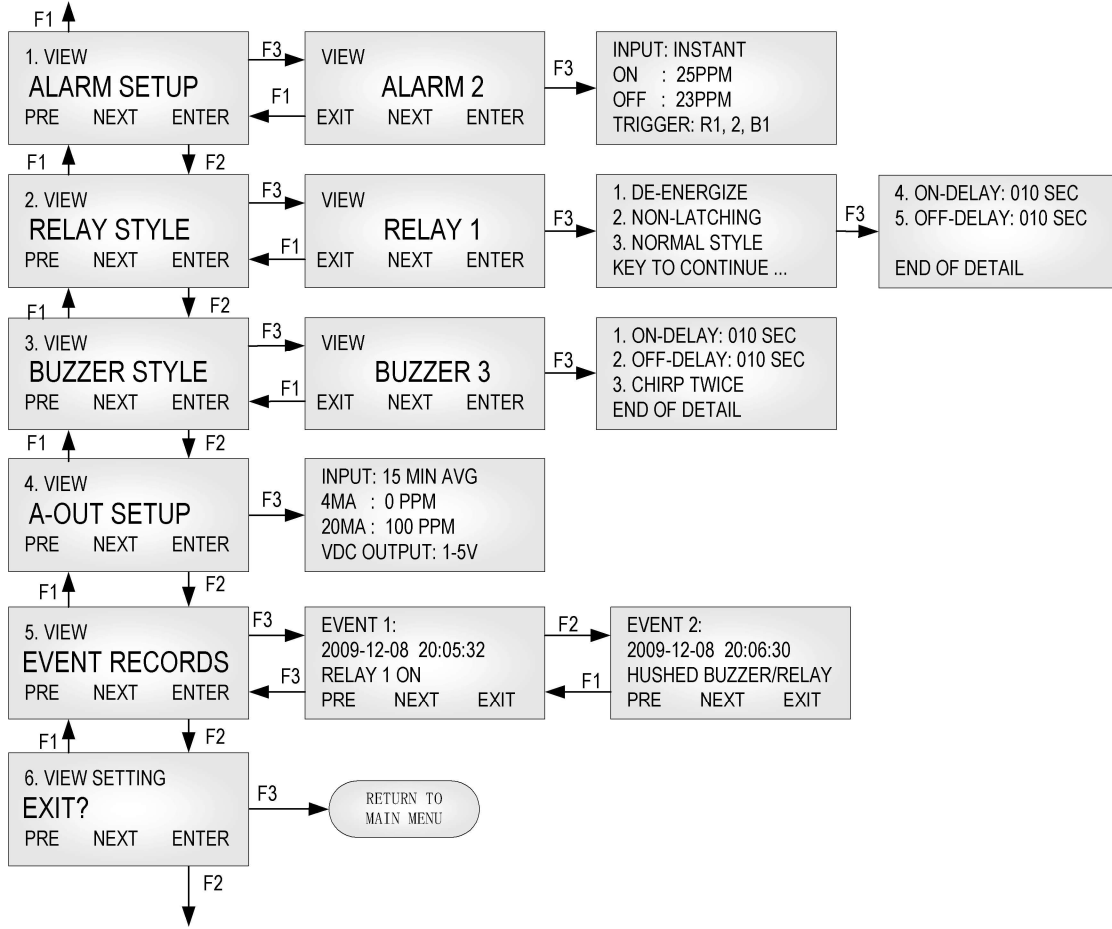

### 3.9 Menu “6\_ALARM SETUP”

The B5C supports alarm 1 to alarm 8.

Alarm is a programmable condition that can receive a selectable input and trigger relays and buzzers.

<p><b>Disabled or Enabled:</b></p>	<p>Each alarm may be individually set to be enabled or disabled. If the alarm is disabled, the alarm will not be used to calculate or trigger anything.</p> <p><b>Default: Alarm 1 to Alarm 4 is enabled. Alarm 5 to Alarm 8 is disabled.</b></p>
<p><b>Input:</b></p>	<p>One of five inputs is selected to calculate the alarm condition status to trigger the selected outputs:</p> <ul style="list-style-type: none"> <li>• <b>INSTANT:</b> instantaneous gas reading.</li> <li>• <b>15 MIN AVG (STEL):</b> Short Term Exposure Limit, average reading over 15 minutes.</li> <li>• <b>8 HOURS AVG (TWA):</b> 8-hour Time Weighted Average, average reading over 8 hours.</li> <li>• <b>DAILY PEAK:</b> daily peak reading.</li> <li>• <b>FAULT:</b> If the unit reports any faults, no matter the gas concentration, it will trigger the selected outputs.</li> </ul>
<p><b>Alarm On and Alarm Off Reading:</b></p>	<p><i>If Alarm On is greater than or equal to Alarm Off:</i></p> <p>Alarm On: Sets the concentration at or above which the relay will actuate.</p> <p>Alarm Off: Sets the concentration at or below which the relay will de-actuate.</p> <p><i>If Action On is less than Action Off:</i></p> <p>Action On: Sets the concentration below that the relay will actuate.</p> <p>Action Off: Sets the concentration above that the relay will de-actuate.</p>
<p><b>Trigger:</b></p>	<p>Trigger Outputs: Relay 1, Relay 2, Relay 3, Buzzer 1, Buzzer 2, Buzzer 3</p>

### 3.10 Menu “7\_RELAY STYLE”

<p><b>Enabled:</b></p>	<p>Each relay may be individually set to be enabled or disabled. If it’s disabled, the relay will always de-actuate no matter what the current gas concentration.</p> <p><b>Default is Enabled.</b></p>
<p><b>Normally De-energized:</b></p>	<p>Each relay may be individually set to be normally energized or normally de-energized.</p> <p><b>Default is normally de-energized.</b></p>
<p><b>Latching:</b></p>	<p>Each relay may be set to latch in actuate status until acknowledged by a front-panel action.</p> <p><b>Default is Non-Latching.</b></p>
<p><b>ON Delay:</b></p>	<p>“Delay on Actuation” or “Delay on Make”. For each relay a separate time delay may be set from 0 to 990 seconds before an alarm condition will cause the relay to actuate.</p> <p><b>Default is 5 seconds.</b></p>
<p><b>OFF Delay:</b></p>	<p>“Delay on De-Actuation” or “Delay on Break”. For each relay a separate time delay may be set from 0 to 990 seconds before a return to a non-alarming signal condition will cause the relay to de-actuate.</p> <p><b>Default is 5 seconds.</b></p>
<p><b>Style:</b></p>	<p>Normal Relay Style: Work as normal relay.</p> <p>Buzzer Style Relay: When the relay is used to control a buzzer or horn. Working as a buzzer style will make the relay have the same function as the buzzer. It will be switched off when performing the Hush Buzzer/Relay function in the Tool Menu.</p> <p><b>Default is OFF.</b></p>

### **3.11 Menu “8\_BUZZER STYLE”**

The buzzer style is almost identical to that of the relays, except the style that represents the buzzer tone options:

- Tone 1: Chirp once.
- Tone 2: Chirp twice.
- Tone 3: Intermittent 50% duty cycle.
- Tone 4: Continuous.

The menus are identical to those for the Relay Style.

### **3.12 Menu “A\_ALL DISABLE”**

This function is for calibration, system testing etc. When All Disable is ON, the status of the relay, buzzer and analog output, etc., will freeze in their current state.

**Default is OFF.**

### **3.13 Menu “B\_SIMULATION”**

Simulation mode is used to assist in testing the installation before commissioning. When simulation is enabled, the unit will not detect gas concentrations; it will display the simulated value and use it to calculate the status of relays and buzzers. This feature is available for evaluating the user settings and testing the installation (e.g.: the activation of the valve, fan speed, relay set points, etc. can be verified.)

Any concentration between 0ppm and 9999ppm can be simulated.

### **3.14 Menu “C\_SITE SERVICE” and “D\_FACTORY SET”**

Factory service staff access only. The customer has no need to operate it.

## **4. BACnet PIC Statement Supported By B5C**

See document: 85950-103-000 (B5 PIC Statement).

### **4.1 Smart Sensor Assembly Replacement**

#### **4.1.1 Disassembling**

Observe all safety and electrical codes and regulations before removing enclosure lid.

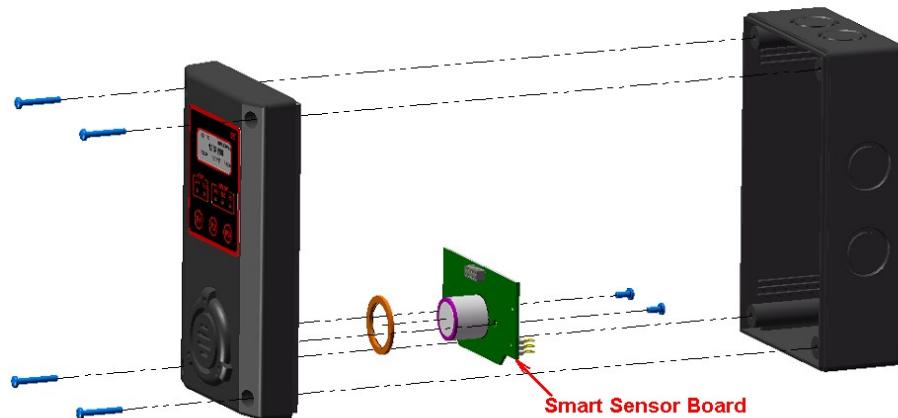

Important: Calibrate the transmitter whenever a component is replaced. But if you replace a smart sensor assembly with a sensor onboard from GES, you don't need to recalibrate the transmitter, as all the calibration information has been stored in the smart sensor board in the factory process.

#### 4.1.2 Replacement Procedure

To replace the entire smart sensor assembly, complete the following steps:

1. Power down the transmitter.
2. Remove the four screws securing the enclosure lid assembly to the base enclosure and remove the enclosure lid assembly.
3. Remove the two screws securing the smart sensor board and remove the smart sensor board from the lid assembly
4. Feed the O-ring over the sensor on the new smart sensor assembly
5. Plug the new smart sensor assembly and secure with two screws. Ensure that the connectors are correctly matched. Incorrect installation may damage the sensor assembly and/or the display board.

### 4.1.3 Replacement Parts

Code	Gas	Symbol	Span	Smart Sensor Assembly
1	Carbon Monoxide	CO	0 - 250ppm	85930-018-001
2	Carbon Monoxide	CO	0 - 1000ppm	85930-018-201

### 4.1.4 Accessories

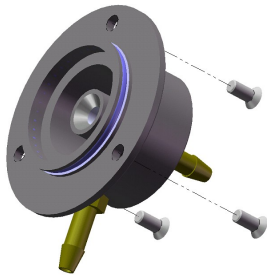

Pump-thru &  
Calibration Cap Kit  
SKU#: 85930-006-000

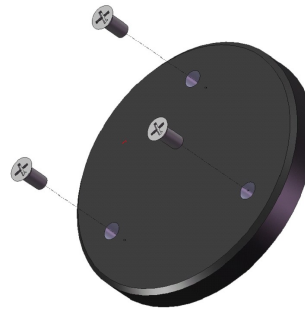

Splash Guard Kit  
SKU#: 85930-007-000

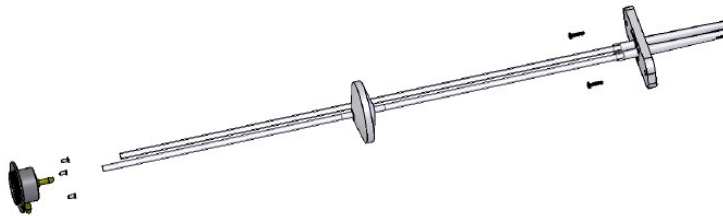

Duct Mount Adapter Kit  
SKU#: 85930-040-000

**Note: For Duct Mount Installation, B5C needs both the Pump-thru Kit and Duct Mount Kit.**



## 5. Troubleshooting

This troubleshooting guide is intended as an aid in identifying the cause of unexpected behavior and determining whether the behavior is due to normal operation or an internal or external problem.

SYMPTOMS	PROBABLE CAUSE	SUGGESTED SOLUTION
RS-485 RX LED or TX LED constantly ON	<ul style="list-style-type: none"> <li>• RS-485 bus connection has a problem</li> <li>• RS-485 driver U6 is damaged</li> <li>• Controller side RS-485 driver has problem</li> </ul>	<ul style="list-style-type: none"> <li>• Disconnect the cable to isolate the problem</li> <li>• Replace U6 IC on main board</li> <li>• Replace the RS-485 driver on the controller</li> </ul>
No response to gas	<ul style="list-style-type: none"> <li>• Sensor screen is dirty</li> <li>• Sensor has expired</li> </ul>	<ul style="list-style-type: none"> <li>• Clean sensor opening</li> <li>• Replace smart sensor assembly, see Replacement Parts</li> </ul>
Apparent false alarm	<ul style="list-style-type: none"> <li>• Puff of gas</li> <li>• Not properly calibrated</li> <li>• Solvent fumes or interference from high levels of interfering gas</li> <li>• Radio frequency interference</li> </ul>	<ul style="list-style-type: none"> <li>• Monitor is functioning</li> <li>• Recalibrate</li> <li>• Remove source of interfering gas</li>   <li>• Check that grounding and shielding is correct</li> </ul>

## WARRANTY STATEMENT

The information contained in this manual is based upon data considered accurate; however, no warranty is expressed or implied regarding the accuracy of this data. All GES equipment is warranted against defects in material and workmanship for a period of two years from date of shipment with the following exceptions:

Electrochemical Sensors (Toxic)	Six Months
Catalytic Sensors (Combustible)	One Year

During the warranty period we will repair or replace, at our discretion, any components or complete units that prove, in our opinion, to be defective. We are not liable for consequential or incidental damage to auxiliary interfaced equipment.

A returned material authorization number should be obtained from the factory prior to returning any goods. All return shipments must be shipped freight prepaid and a copy of the maintenance records should accompany the unit concerned.

Warranty should be considered F.O.B. the factory. Labour and travel time are chargeable for any field site visits required for warranty work.

## LIMITED LIABILITY

All GES systems shall be installed by a qualified technician/electrician and maintained in strict accordance with data provided for individual systems in the form of installation/maintenance manuals. GES assumes no responsibility for improper installation, maintenance, etc., and stresses the importance of reading all manuals. GES shall not be responsible for any liability arising from auxiliary interfaced equipment nor any damage resulting from the installation or operation of this equipment.

GES's total liability is contained as above with no other liability expressed or implied, as the purchaser is entirely responsible for installation and maintenance of systems.

This warranty is in lieu of all other warranties, expressed or implied, and no representative or person is authorized to represent or assume for GES any liability in connection with the sales of our products other than that set forth herein.

NOTE: Due to on-going product development, GES reserves the right to change specifications without notice and will assume no responsibility for any costs as a result of modifications.

For further information or assistance, contact:

**Greystone Energy Systems, Inc.**  
150 English Drive, Moncton,  
New Brunswick, Canada E1E 4G7  
5935 Ottawa Street, PO Box 749  
Ph: +1 (506) 853-3057 Fax: +1 (506) 853-6014  
North America: 1-800-561-5611  
E-mail: mail@greystoneenergy.com