

INTRODUCTION

The room RH/T transmitter uses highly accurate and field-proven RH and temperature sensors in an attractive, low profile enclosure to monitor room relative humidity and temperature levels. Additional options include an occupancy override button, and a LCD display. The RH and temperature outputs are available in either a 4-20 mA, 0-5 or 0-10 Vdc signal.

BEFORE INSTALLATION

Read these instructions carefully before installing and commissioning the device. Failure to follow these instructions may result in product damage. Do not use in an explosive or hazardous environment, with combustible or flammable gases, as a safety or emergency stop device or in any other application where failure of the product could result in personal injury. Take electrostatic discharge precautions during installation. **Do not exceed device ratings.**

MOUNTING

The room RH/T transmitter installs directly on a standard electrical box and should be mounted five feet from the floor of the area to be controlled. Do not mount the sensor near doors, opening windows, supply air diffusers or other known air disturbances. Avoid areas where the detector is exposed to vibrations or rapid temperature changes.

The cover is hooked to the base at the top edge and must be removed from the bottom edge first. Use a small Phillips screwdriver to loosen the security screw as shown in Figure 1. (Complete removal of this screw is not required). Use the screwdriver to carefully pry each bottom corner if necessary. Tip the cover away from the base and sit it aside as shown in Figure 2.

The PCB must be removed from the base to access the mounting holes. Follow usual anti-static procedures when handling the PCB and be careful not to touch the sensors. The PCB is removed by pressing the enclosure base to unsnap the latch near the bottom edge, then the PCB can be lifted out of the base as shown in Figure 3.

Sit the PCB aside until the base is mounted on the wall. For added protection, place the PCB in the supplied anti-static bag.

Mount the base by screwing to an electrical box or directly to the wall as shown in Figure 4. The mounting hole locations are shown on page 3.

After the base is screwed to an electrical box or the wall using the appropriate holes, remove the PCB from the anti-static bag, feed connection wires through center hole and place the top of PCB into the PCB holders on backplate and snap bottom of PCB into place as shown in Figure 4.

Make wire connections as per the Wiring Illustrations on Page 2 and install decorative cover by placing the top of the cover into the cover holder on the top of the backplate and snapping the bottom into place as shown in Figure 4. Tighten security screw with a Phillips screwdriver.

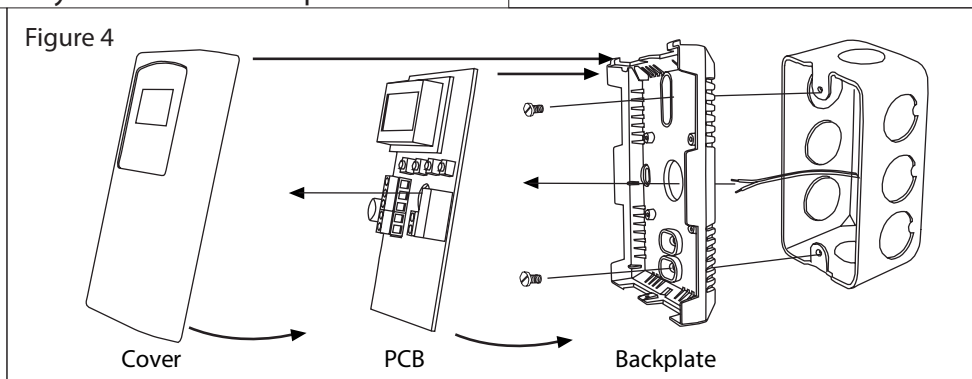
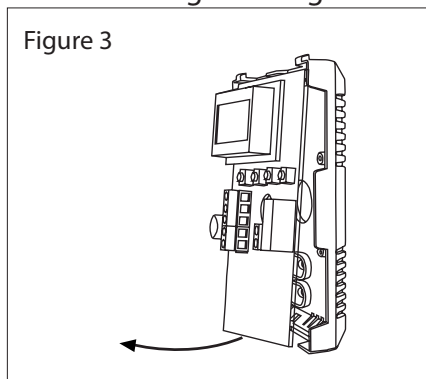
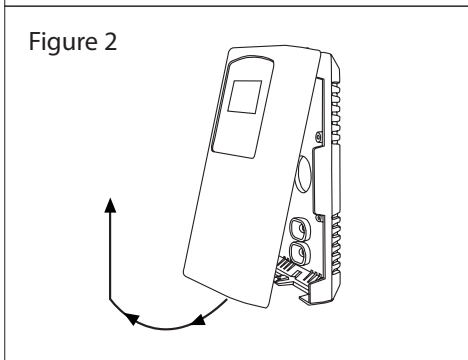
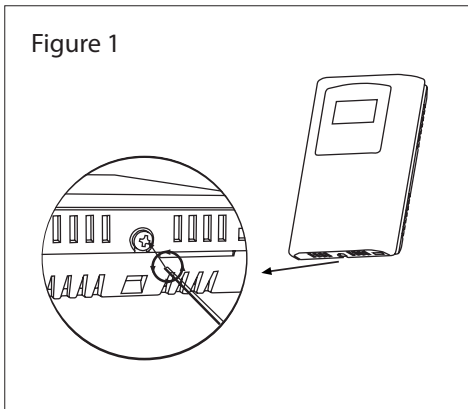

WIRING

Deactivate the 24 Vac/dc power supply until all connections are made to the device to prevent electrical shock or equipment damage. Follow proper electrostatic discharge (ESD) handling procedures when installing the device or equipment damage may occur.

Use 22 AWG shielded wiring for all connections and do not locate the device wires in the same conduit with wiring used to supply inductive loads such as motors. Connect the cable shield to ground at the controller only. Make all connections in accordance with national and local codes.

Connector layout is shown in Figure 5. Diagram shown includes all options. If option is not ordered, connector will not be present. For Figure 5 remove FAN+, FAN-, TIP MID and RING text and connectors from figure. They are not offered on product.

Figure 5

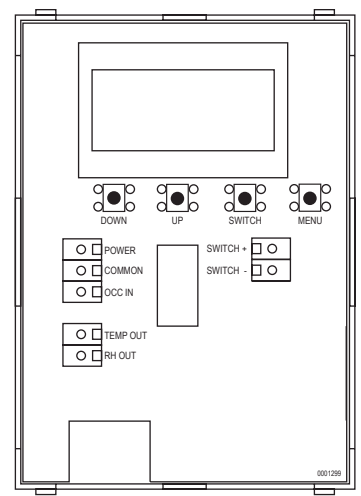
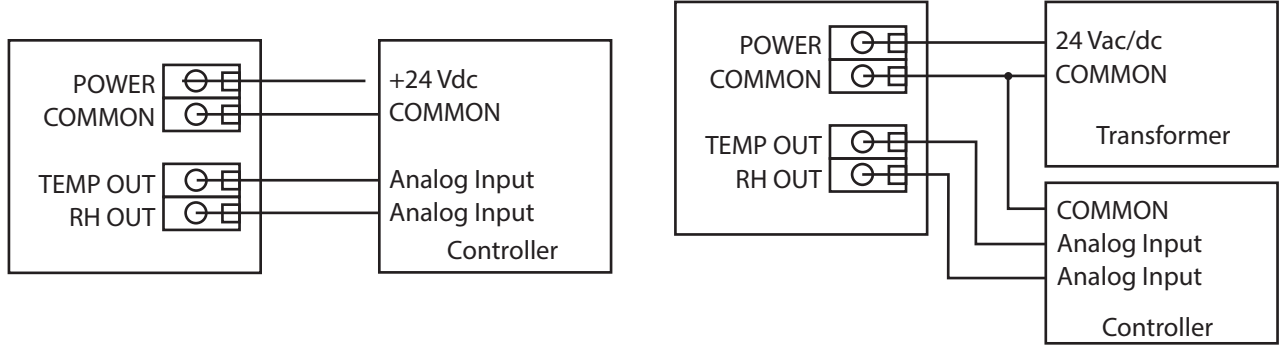

Figure 6



This is a sourcing device and requires from 4 to 12 wires to implement all the features. Connect the plus dc or the ac voltage hot side to the POWER terminal. The power supply common is connected to the COMMON terminal as shown in Figure 6. The device is reverse voltage protected and will not operate if connected backwards. It has a half-wave power supply so the supply common is the same as the signal common. Several devices may be connected to one power supply and the output signals all share the same common. Use caution when grounding the secondary of a transformer or when wiring multiple devices to ensure the ground point is the same on all devices and the controller.

Figure 7

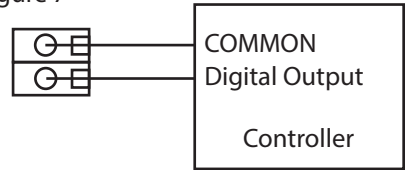
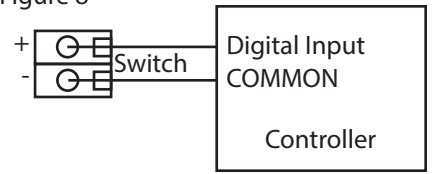

Figure 8



The analog outputs are available on the RH OUT and TEMP OUT terminals as shown in Figure 6. For 4-20 mA output type, all outputs operate in the Active mode and do not require a loop power supply. This means the signal current is generated by the transmitter and must not be connected to a powered input or device damage will result. Check the controller Analog Input to determine the proper connection before applying power. All output signals are referenced to the COMMON terminal. The analog output signals are typically connected directly to the Building Automation System and used as control parameters or for logging purposes.

The device is also available with field-selectable 0-5 or 0-10 Vdc voltage signal outputs which connect directly to a high impedance analog input. In either case the terminal designations are the same and the signals are referenced to COMMON.

The OCC IN terminal is a digital input that controls the OCC segment on the LCD to indicate an occupied condition. It can be connected to a 0/5V digital signal or a dry contact signal. This is usually an active low input signal and requires that the OCC IN terminal be shorted to COMMON to activate the input as shown in Figure 7.

The override switch output is a dry-contact and is available on the SWITCH + and SWITCH – terminals. It is typically connected to a low-voltage digital input on the controller to indicate room occupancy or override when the button is activated as shown in Figure 8.

START-UP

Verify that the transmitter is properly wired and connections are tight. Apply power and note that the LCD will begin displaying the RH and temperature levels. The display normally toggles between the two values on a 2 second interval. Both output signals will also be available immediately after start-up.

LCD DISPLAY

If the device has both RH and temperature signals, then the multi-function display is factory set to display both measurement values at two second intervals. The RH will be displayed as 0 - 100 %RH for two seconds and then the temperature will be displayed as 0.0 - 35.0 °C for two seconds. This cycle will repeat constantly.

The Setup Menu can be used to modify the displayed information. The installer can select to only display RH or temperature continuously. The device supports four temperature ranges that may also be selected in the menu. The default is 0-35 °C but this may be changed to 32-95 °F and the output signal will stay the same. Also, the temperature range may be changed to 32-122 °F or 0-50 °C and the output signal scaling will change to match the display.

OUTPUTS

The RH output is scaled such that 4-20 mA (or 0-5 or 0-10 Vdc) equals 0-100 %RH and is temperature compensated over the full 0-50 °C temperature range. The temperature output is scaled such that 4-20 mA (or 0-5 or 0-10 Vdc) equals either 0-35 °C, 32-95 °F, 0-50 °C or 32-122 °F depending on which range is selected in the menu. The factory default range is 0-35 °C.

Note that all programmed parameters are saved in non-volatile memory so the device will remember the settings after a power-outage.

SET-UP MENU

The menu has several items as shown below and the device cover must be removed to access the menu. To enter the menu, press and release the <MENU> key while in normal operation. This will enter the Setup Menu step 1, pressing the <MENU> key a second time advances to step 2. Each press of the <MENU> key advances the menu item. No values are changed by using the <MENU> key but the previous value is saved, so any changes made will be saved by pressing the <MENU> key. The <UP> and <DOWN> keys are used to make changes to program variables by scrolling through the available options. When a value is changed, use the <MENU> key to save it to memory and advance to the next menu item.

Setup Menu operation is explained below and the factory default values are shown.

<MENU> Press and release the <MENU> key to enter the Setup Menu

1. CELSIUS/FAHRENHEIT



The temperature scale defaults to Celsius (°C). It can be changed to Fahrenheit (°F) by using the <UP> or <DOWN> keys. This setting will effect other parameters.

<MENU> Press to advance to next menu item

2. TEMPERATURE RANGE



Two temperature ranges are available for both °C and °F, 0-35 °C (32-95 °F) or 0-50 °C (32-122 °F). This can be changed with <UP> or <DOWN>. This item depends on the C/F setting.

<MENU> Press to advance to next menu item

3. TEMPERATURE OFFSET



Use <UP> or <DOWN> to add or subtract an offset to the temperature output signal and display. The default is 0 but can be changed from -5.0 to +5.0 °C for temperature calibration.

<MENU> Press to advance to next menu item

4. RH OFFSET



Use <UP> or <DOWN> to add or subtract an offset to the RH output signal and display. The default is 0 but can be changed from -20 to +20 %RH for humidity calibration.

<MENU>

Press to advance to next menu item

5. DISPLAY MODE



Select parameters to display on the LCD. 1 = Temperature only, 2 = RH only and 3 = T + RH alternately every 2 seconds. Change with <UP> or <DOWN>.

<MENU>

Press to advance to next menu item

6. OUTPUT SIGNAL



This only applies for models with voltage outputs. Default is 5 for 0-5 Vdc output signal. Can change with <UP> or <DOWN> to 10 for 0-10 Vdc outputs.

<MENU>

Press to advance to next menu item

7. DISPLAY MODE



The default OCC signal type is active low (Lo). Can change with <UP> or <DOWN> to active high (Hi) to reverse the OCC action. By default, shorting the OCC input to common will turn on the OCC LCD segment.

<MENU>

Press to advance to next menu item

8. BACKLIGHT ENABLE



Use the <UP> or <DOWN> keys to enable or disable the LCD backlight. bL0 = backlight auto, bL1 = backlight off, bL2 = backlight on.

<MENU>

Press to exit the set-up menu and return to normal operation

DIMENSIONS

