

INTRODUCTION

The multi point duct average temperature transmitter incorporates numerous precision platinum RTD's at equal distances and encapsulated in a 7.94 mm (0.3125") OD, soft copper probe and is available in various lengths. All probes provide excellent heat transfer, fast response and resist moisture penetration. A transmitter that provides a high accuracy signal with excellent long term stability, low hysteresis and fast response is available with various ranges. A compact ABS enclosure with a hinged and gasketed cover is provided for ease of installation.

BEFORE INSTALLATION

Read these instructions carefully before installing and commissioning the temperature sensor. Failure to follow these instructions may result in product damage. Do not use in an explosive or hazardous environment, with combustible or flammable gases, as a safety or emergency stop device or in any other application where failure of the product could result in personal injury.

Do not exceed the device ratings.

MOUNTING

The transmitter installs directly into any air duct with several lengths available for a wide range of duct widths/diameters. Select a suitable installation area in the middle of the duct wall. To achieve the best reading, do not place in an area where air stratification may be present. Mount the sensor at least 1.5 m (5') in either direction from elbows, dampers, filters or other duct restrictions. Avoid areas where the sensor is exposed to vibrations or rapid temperature changes.

Once a suitable spot is selected, drill a 9.5 - 12 mm (3/8" - 1/2") hole. Uncoil the copper probe and slide into the drilled hole until the enclosure is flush against the duct. The airflow direction is not important. Secure the enclosure to the duct with #10 x 25 mm (1") self tapping screws (not provided). Tighten screws until the enclosure is tight against the duct and ensure that there is no movement of the enclosure as shown in Figure 1.

A foam gasket is provided on the back of the enclosure that provides a tight seal against any air leaks.

The probe can be easily shaped to fit any duct size but observe a minimum bend radius of 4" to prevent damage to the wire or sensors. Criss-cross the duct multiple times so that the probe covers a large section of the duct. The probe needs to be fastened onto hangers using tube clamps or wire ties. See Figure 2.

The enclosure has a hinged cover with a latch. Open the cover by pulling slightly on the latch on the right side of the enclosure, at the same time pulling on the cover, as illustrated in Figure 3.

A 1/2" NPT threaded connection hole is provided in the bottom of the enclosure. Screw the EMT connector or cable gland connector in until tight. See figure 4. It is recommended that weatherproof conduit or cable gland fittings be used. The F style enclosure includes a 1/2" NPT to M16 thread adapter and cable gland fitting.

Make wiring connections as per the "Wiring" illustrations on Page 2.

Swing door closed until securely latched. For added security, 2 screws are provided that may be installed in the integrated screw tabs. See Figure 5.

Figure 1

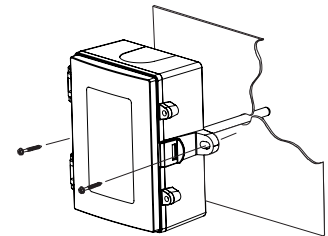

Figure 2

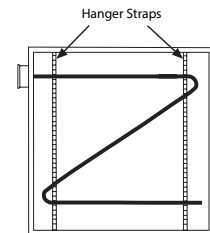

Figure 3

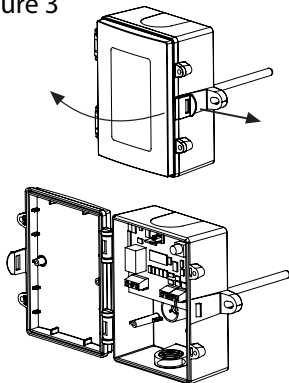

Figure 4

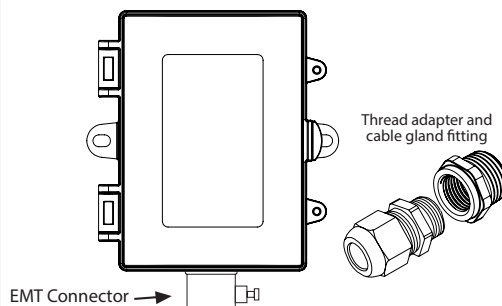
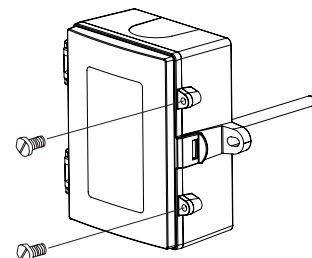
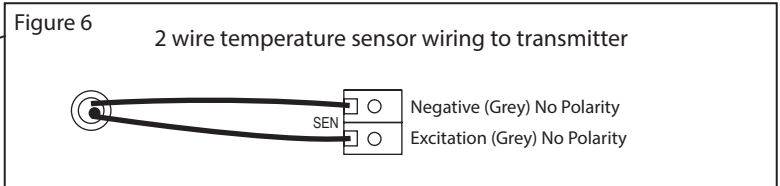
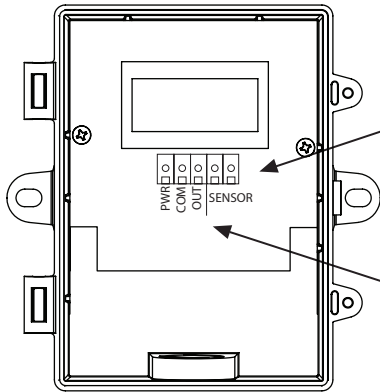

Figure 5



WIRING

- Deactivate the 24 Vac/dc power supply until all connections are made to the device to prevent electrical shock or equipment damage.
- Use 14-22 AWG shielded wiring for all connections and do not locate the device wires in the same conduit with wiring used to supply inductive loads such as motors. Make all connections in accordance with national and local codes.
- The temperature transmitter comes with the temperature sensor pre-wired to the transmitter board. If removal is required for installation then it may be re-wired as shown in Figure 6.
- Pull at least six inches of control wire into the enclosure, then complete the wiring connection according to the wire diagram for the applicable power supply and output signal type as shown in Figure 7.
- Connect the DC positive or the AC voltage hot side to the PWR terminal. For voltage output or AC power, the supply Common is connected to the COM terminal. The device is reverse voltage protected and will not operate if connected backwards. It has a half-wave power supply so the supply Common is the same as the signal Common. See Figure 7.
- The analog output is available on the OUT terminal. Check the controller Analog Input to determine the proper connection before applying power as shown in Figure 7.
- Once all connections are made and checked, power can be applied.



SPECIFICATIONS:

Sensor Type: 1000 ohm platinum RTD
 Sensor Accuracy: $\pm 0.3^{\circ}\text{C}$ ($\pm 0.94^{\circ}\text{F}$) @ 0°C (32°F)
 Wire Material: PVC insulated, parallel bonded, 22 AWG
 Probe Sensing Range: -20 to 60°C (-4 to 140°F)
 Probe Material: Soft copper
 Probe Diameter: 7.94 mm (0.312")
 Wire Material: FT-6 plenum rated cable
 Standard lengths: 1800, 3600, 6100, 7300 mm
 (6', 12', 20', 24')
 Output Signal: 4-20 mA current loop, 0-5 vdc, or 0-10 vdc
 (factory configured)
 Transmitter Accuracy: $\pm 0.2\%$ of span, including linearity
 Power Supply: 15 to 30 Vdc, 12 to 28 Vac
 Consumption (max): 20 mA for current, 11 mA for voltage
 Protection Circuitry: Reverse voltage protected and output limited
 Output Drive @ 24 Vdc: 700 ohms max for current output,
 20K ohms min for voltage output
 LCD Display Units: $^{\circ}\text{C}$ or $^{\circ}\text{F}$ (factory configured)
 Display Range: 3 digit for -88.8 to 888 as required
 Display Size: 38.1 mm W x 16.5 mm H (1.5" to 0.65")
 Digit Height: 11.4 mm (0.45") plus $^{\circ}\text{C}/^{\circ}\text{F}$ symbol
 Ambient Operating Range: 0 to 50°C (32 to 122°F), 0-95 %RH
 Enclosure: Grey polycarbonate UL94-V0, IP65 (NEMA 4X)
 F style includes thread adapter (1/2" NPT to M16)
 and cable gland fitting
 Wiring Connections: Screw terminal block (14 to 22 AWG)
 Country of Origin: Canada

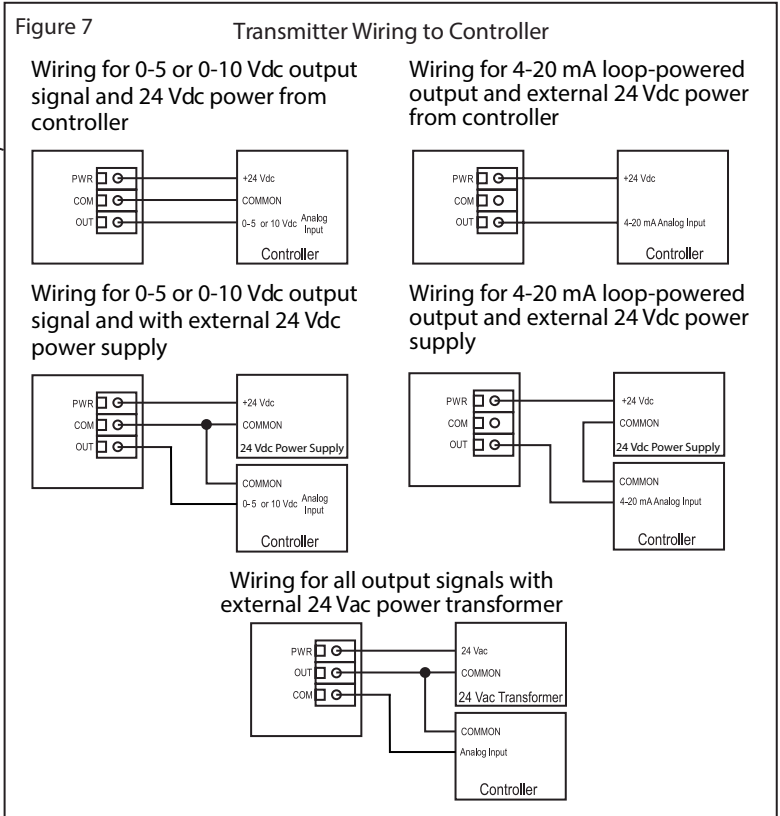

DIMENSIONS

