

#### INTRODUCTION

The high accuracy single point strap-on temperature transmitter incorporates a precision platinum RTD encapsulated in a 6 mm (0.236") OD, 304 stainless steel probe and is available in various lengths. All probes provide excellent heat transfer, fast response and resist moisture penetration. A transmitter that provides a high accuracy signal with excellent long term stability, low hysteresis and fast response is available with various ranges. A compact ABS enclosure with a hinged and gasketed cover is provided for ease of installation.

#### BEFORE INSTALLATION

Read these instructions carefully before installing and commissioning the temperature transmitter. Failure to follow these instructions may result in product damage. Do not use in an explosive or hazardous environment, with combustible or flammable gases, as a safety or emergency stop device or in any other application where failure of the product could result in personal injury. **Do not exceed the device ratings.**

#### MOUNTING

The strap-on sensor installs directly onto any pipe where an immersion sensor with a thermowell can't be installed.

Once a suitable spot is selected, remove a small section of insulation, if present, and set aside. It is recommended that thermal compound be used to improve heat transfer. Spread a liberal amount on the pipe. Lay probe in thermal compound and secure sensor to pipe using a worm gear clamp (not included). For added protection it is recommended to wrap probe cable around pipe 1 to 2 times as shown in Figure 1. Re-install insulation if present, allowing sensor cable to protrude.

Mount the enclosure on a flat surface in close proximity to the area where the probe inserted on the pipe. Secure the enclosure with two #10 x 25 mm (1") self tapping screws (not provided). As shown in Figure 2.

The enclosure has a hinged cover with a latch. Open the cover by pulling slightly on the latch on the right side of the enclosure. At the same time pulling on the cover, as shown in Figure 3.

A 1/2" NPT threaded connection hole is provided in the bottom of the enclosure. Screw the EMT connector or cable gland connector in until tight. See Figure 4. It is recommended that weatherproof conduit or cable gland fittings be used. The E style enclosure includes a 1/2" NPT to M16 thread adapter and cable gland fitting.

Make wiring connections as per the "Wiring" illustrations on Page 2.

Swing door closed until securely latched. For added security, 2 screws are provided that may be installed in the integrated screw tabs. See Figure 5.

Figure 1

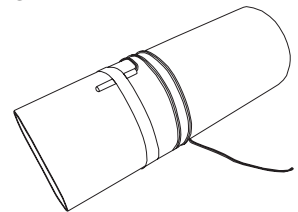

Figure 2

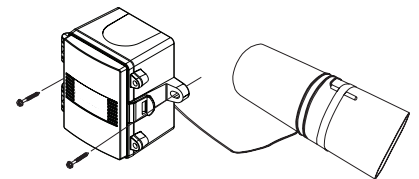

Figure 3

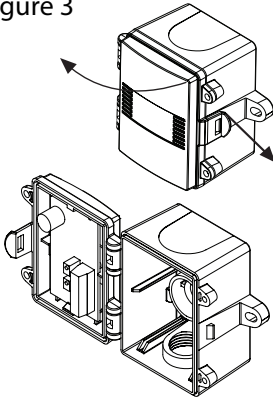

Figure 4

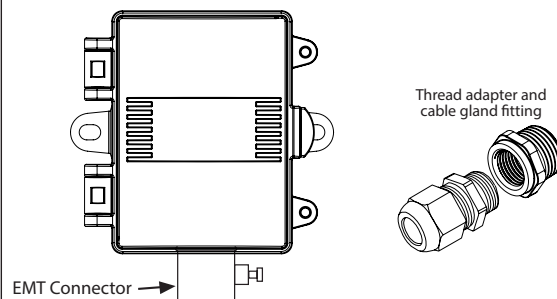
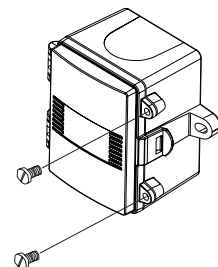
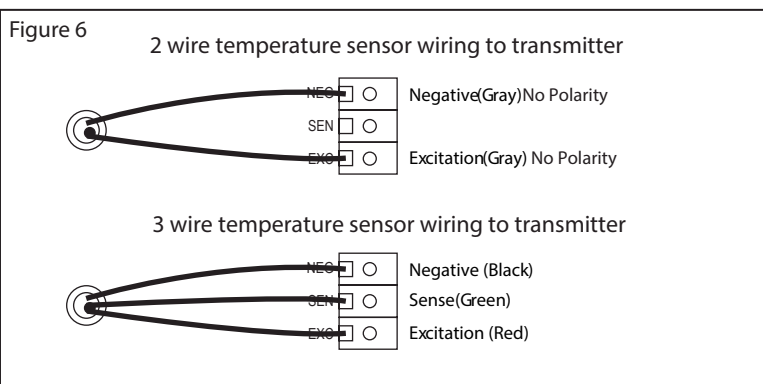
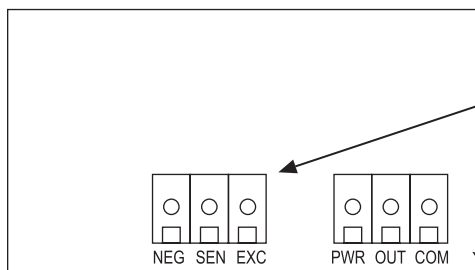

Figure 5



## WIRING

- Deactivate the 24 Vac/dc power supply until all connections are made to the device to prevent equipment damage.
- Use 14-22 AWG shielded wiring for all connections and do not locate the device wires in the same conduit with wiring used to supply inductive loads such as motors. Make all connections in accordance with national and local codes.
- The temperature transmitter comes with the temperature sensor pre-wired to the transmitter board. If removal is required for installation then it may be re-wired as shown in Figure 6.
- Pull at least six inches of control wire into the enclosure, then complete the wiring connection according to the wire diagram for the applicable power supply and output signal type as shown in Figure 7.
- Connect the DC positive or the AC voltage hot side to the PWR terminal. For voltage output or AC power, the supply Common is connected to the COM terminal. The device is reverse voltage protected and will not operate if connected backwards. It has a half-wave power supply so the supply Common is the same as the signal Common. See Figure 7.
- The analog output is available on the OUT terminal. Check the controller Analog Input to determine the proper connection before applying power as shown in Figure 7.
- Once all connections are made and checked, power can be applied.



## SPECIFICATIONS:

Sensor Type:	1000 ohm platinum RTD
Sensor Accuracy:	RTD Class A: ±0.15°C @ 0°C RTD 1/3 DIN: ±0.1°C @ 0°C RTD 1/10 DIN: ±0.03°C @ 0°C
Temperature Range:	-20 to 105°C (-4 to 221°F)
Probe Sensing Range:	-20 to 105°C (-4 to 221°F)
Wire Material:	PVC insulated, parallel bonded, 22 AWG
Wire Length:	1.524 m (5')
Probe Material:	304 Series Stainless Steel
Probe Diameter:	6 mm (0.236")
Standard Lengths:	50, 100, 150, 200, 300, 450 mm (2", 4", 6", 8", 12", 18")
Output Signal:	4-20 mA current loop, 0-5 Vdc, or 0-10 Vdc (factory configured)
Transmitter Accuracy:	±0.125% of span, including linearity
4-20 mA loop power supply:	15-35 Vdc or 22-32 Vac
Minimum Loop Current:	2 mA nominal (occurs with shorted sensor)
Maximum Loop Current:	22.5 mA nominal (occurs with open sensor)
Maximum Loop Load:	>600ohms
0-5 Vdc Power Supply:	10-35 Vdc or 10-32 Vac
0-10 Vdc Power Supply:	15-35 Vdc or 15-32 Vac
Maximum Current (Voltage):	5 mA nominal
Maximum Output (Voltage):	Limited to <5.5 Vdc for 0-5 Vdc, <10.5 Vdc for 0-10 Vdc
Input Voltage Effect:	Negligible over specified operating range
Protection Circuitry:	Reverse voltage protected and output limited
Ambient Operating Range:	0 to 50°C (32 to 122°F), 0-95 %RH non-condensing
Enclosure:	ABS - UL94-V0, IP65 (NEMA 4X) E - includes thread adapter (1/2" NPT to M16) and cable gland fitting
Wiring Connections:	Screw terminal block (14 to 22 AWG)
Country of Origin:	Canada

\*This product is factory calibrated and any field adjustment will void the warranty.

## DIMENSIONS

