

# Ultra Low Pressure Transmitter

Installation Instructions

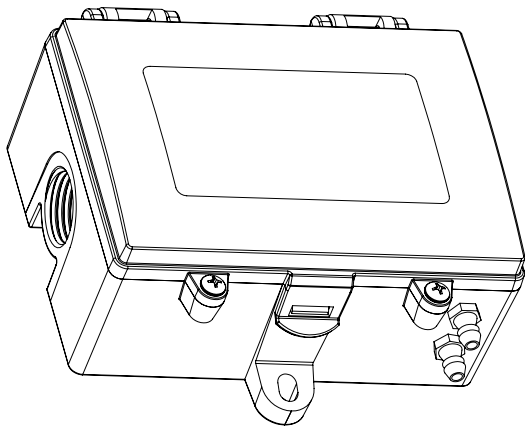

## INTRODUCTION

The Ultra Low Pressure Transmitter is used to measure differential pressure up to 1"wc or 250 Pa. It combines precision high sensitivity silicon sensing capabilities and the latest ASIC technology to substantially reduce offset errors due to changes in temperature, stability to warm-up, long term instability and position sensitivity. It is ideal for monitoring pressure for air or other clean inert gas. It features bi-directional pressure measurement, an on-board auto-zero function, a backlight LCD to display the pressure value and an alarm relay with variable trip points. The device is field-configurable via the local menu.

## BEFORE INSTALLATION

Read these instructions carefully before installing and commissioning the UP Pressure Transducer. Failure to follow these instructions may result in product damage. Do not use in an explosive or hazardous environment, with combustible or flammable gases, as a safety or emergency stop device or in any other application where failure of the product could result in personal injury. **Take electrostatic discharge precautions during installation and do not exceed the device ratings.**

## MOUNTING

The Ultra Low Pressure Transmitter mounts using the two holes on the base of the unit. See Figure 1. Leave enough space around the unit to connect the pressure tubing and avoid locations with severe vibrations, excessive moisture or rapid temperature changes. It should be mounted on a vertical surface with the pressure ports on the bottom and the cable entrance on the left.

The enclosure has a standard 1/2" conduit opening and may be installed with either conduit and a conduit coupler or a cable gland type fitting.

The enclosure has a hinged cover with a latch. Open the cover by pulling slightly on the latch on the bottom of the enclosure. At the same time pulling on the cover, as illustrated in Figure 2.

A 1/2" NPT threaded connection hole is provided in the bottom of the enclosure. Screw the EMT connector or cable gland connector in until tight. See Figure 3. It is recommended that weatherproof conduit or cable gland fittings be used. The F style enclosure includes 1/2" NPT to M16 thread adapter and cable gland fitting.

Make wiring connections as per the "Wiring" illustrations on Page 2.

Swing door closed until securely latched. For added security, 2 screws are provided that may be installed in the integrated screw tabs. See Figure 4.

Figure 1

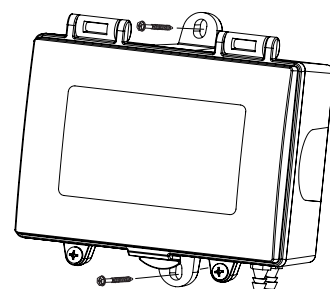

Figure 2

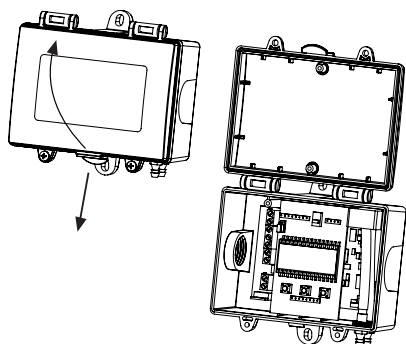

Figure 3

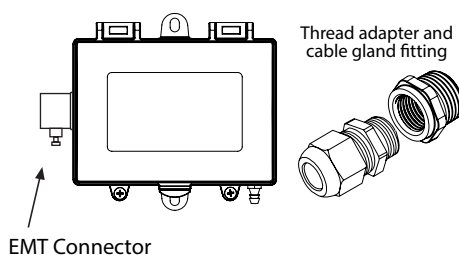
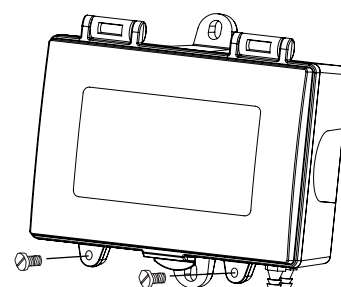

Figure 4



# WIRING

The transmitter has standard screw block connectors. Use shielded twisted pair wiring of at least 22 AWG for all connections and do not run device wires in the same conduit with wiring used to supply inductive loads such as motors. Disconnect the power supply before making any connections to prevent electrical shock or equipment damage. Make all connections in accordance with national and local electrical codes.

This is a 3-wire sourcing device. Connect the positive dc or the ac voltage hot side (24 Vac/dc  $\pm$  10%) to the POWER terminal. The supply common is connected to the COMMON terminal. The device is reverse voltage protected and will not operate if connected backwards. It has a half-wave rectified power supply so the supply common is the same as the signal common. Several devices may be connected to one power supply and the output signals all share the same common. Use caution when grounding the secondary of a transformer or when wiring multiple devices to ensure the ground point is the same on all devices and the controller.

The analog output is available on the OUT terminal. This signal is switch selectable for either voltage or 4-20 mA active output. In voltage mode the output is 0-5 or 0-10 Vdc, selectable in the User Menu. The current output operates in the Active mode and does not require a loop power supply. This means the signal current is generated by the transmitter and must not be connected to a powered input or device damage will result. Check the controller Analog Input to determine the proper connection before applying power. Both current and voltage signals are referenced to the COMMON terminal. The voltage output signal has a minimum load that it is able to drive, similarly the current signal has a maximum load. Follow the ratings in the Specification section or inaccurate readings may result.

The remote zero feature may be used by wiring a dry-contact (relay only) digital output between the ZERO and COMMON terminals. Do not apply voltage to the ZERO terminal.

The RELAY output is a normally open dry contact. This signal can be used to directly control an alarm, ventilation fan or may be connected to a digital input of the BAS for status monitoring. Ensure any loads connected to the relay is within the relay rating in the Specification section.

Figure 5

Wiring all output signals and 24 Vdc power from controller

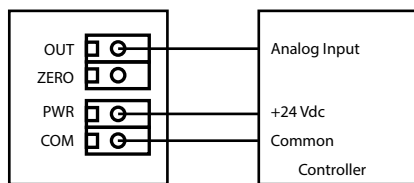

Wiring all output signals and external 24 Vdc power supply

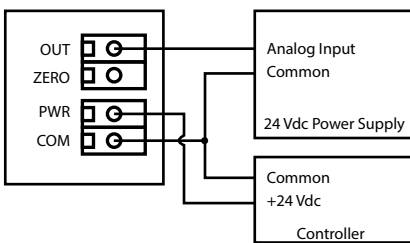

Wiring all output signals and external 24 Vac power supply

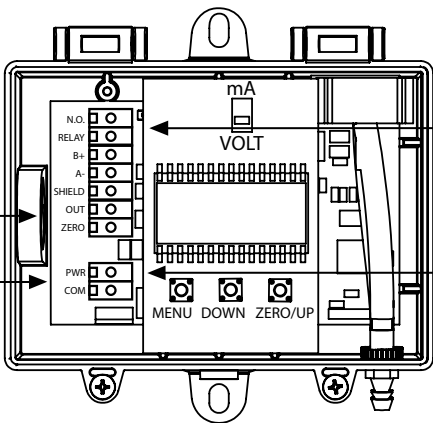
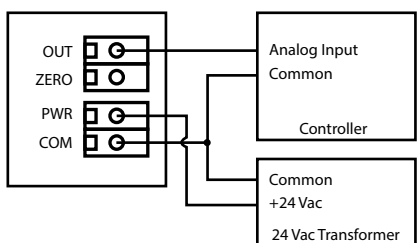

Figure 6

Relay Output

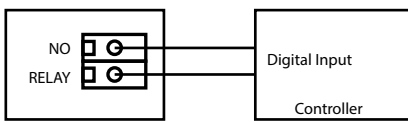

Figure 8

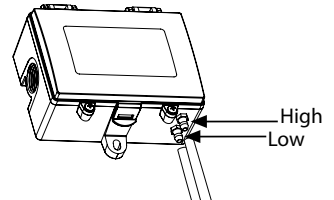

Figure 7

Remote Zero

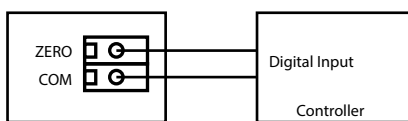
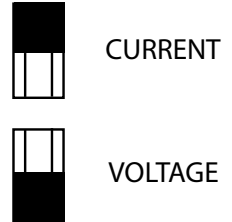

Figure 9



## START-UP

The Setup Menu can be accessed by pressing the internal <MENU> key at any time after the start-up mode.

Upon applying power to the device, it will enter the start-up mode. During start-up the alarm condition is set to off so the relay is off and the analog output is set to the midpoint. The LCD will display all segments for 2 seconds and then the software version number, such as 1.

## USER MENU

The User Menu can be accessed by pressing the <MENU> key at any time after the start-up mode. Note that the <Auto-Zero> key function changes to an <UP> key function when a menu is active.

The system suspends operation when in the menu and holds the last pressure value as the output value. If an alarm condition was present then it will be reset to enter the menu and alarm operation is disabled while in the menu (except for alarm test). If the User Menu is not active for 5 minutes (no key press), then the menu will exit and the device returns to normal operation.

The Setup menu operation and parameters are explained below

<MENU> Press and release to enter the SETUP menu

### 1. OUTPUT



The setting has no affect unless the PCB switch is in the VOLT position. The analog output voltage scale defaults to 0-5 Vdc. Use <UP> or <DOWN> to toggle it to 0-10 Vdc



<MENU> Press to advance to next menu item

### 2. PRESSURE SCALE



The pressure scale defaults to "wc. Use <UP> or <DOWN> to toggle it to Pa.

<MENU> Press to advance to next menu item

### 3. PRESSURE RANGE



The default pressure range is HI ( $\pm 1$  "wc,  $\pm 250$  Pa,  $\pm 0.25$  "wc or  $\pm 60$  Pa depending on the model and units). Use <UP> or <DOWN> to toggle to LO ( $\pm 0.5$  "wc,  $\pm 125$  Pa,  $\pm 0.125$  "wc or  $\pm 30$  Pa depending on the model and units). Applicable units symbol is displayed.



<MENU> Press to advance to next menu item

### 4. DIRECTIONALITY



The default pressure range is bi (bidirectional  $\pm$  max). Use <UP> or <DOWN> to toggle to uni (unidirectional 0-max). Applicable units symbol is displayed.



<MENU>

Press to advance to next menu item

## 5. PRESSURE AVERAGING



The pressure averaging time defaults to 5" (seconds). This can be changed from 1-60" (seconds) using <UP> or <DOWN>.

<MENU>

Press to advance to next menu item

## 6. ALARM



**Only if a relay is installed.** The alarm enable/disable defaults to enable (On). The alarm can be disabled here. Use <UP> or <DOWN> to disable (OFF) the alarm. If the alarm is disabled no alarm condition will be set. Note if the alarm is disabled, then none of the alarm menu settings will be shown in the menu. Use <MENU> to save and advance.

<MENU>

Press to advance to next menu item

## 7. HIGH PRESSURE ALARM

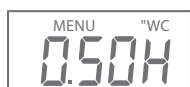

The high pressure alarm limit defaults to about 75% of the range. This equals + 0.50 for the  $\pm 1$  "wc range, + 130 for the  $\pm 250$  Pa range, etc. It can be changed using <UP> or <DOWN> throughout the range. Resolution for each range is:  $\pm 1$  "wc (0.05),  $\pm 0.25$  "wc (0.01),  $\pm 250$  Pa (10) and  $\pm 60$  Pa (2). Note that the  $\pm 250$  Pa range must be displayed as /10 such that it is - 25H to 25H.

<MENU>

Press to advance to next menu item

## 8. LOW PRESSURE ALARM

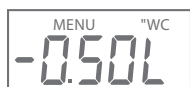

The low pressure alarm limit defaults to about 25% of the range. This equals - 0.50 for the  $\pm 1$  "wc range, - 130 for the  $\pm 250$  Pa range, etc. It can be changed using <UP> or <DOWN> throughout the range. Resolution for each range is:  $\pm 1$  "wc (0.05),  $\pm 0.25$  "wc (0.01),  $\pm 250$  Pa (10) and  $\pm 60$  Pa (2). Note that the  $\pm 250$  Pa range must be displayed as /10 such that it is - 25H to 25H.

<MENU>

Press to advance to next menu item

## 9. ALARM DELAY



The alarm on delay defaults to 5" (seconds). It can be changed from 1-59" (seconds) and 1-10' (minutes) using <UP> or <DOWN>.

<MENU>

Press to advance to next menu item

## 10. ALARM DELAY



The alarm off delay defaults to 5" (seconds). It can be changed from 1-59" (seconds) and 1-10' (minutes) using <UP> or <DOWN>.

<MENU>

Press to advance to next menu item

## 11. ALARM TEST



The alarm test defaults to OFF. It can be set to On using <UP> or <DOWN>. This forces the relay to activate.

<MENU>

Press to advance to next menu item

## 12. BACKLIGHT



The backlight operation defaults to “bL.2” for Auto operation. It can be set to “bL.0” using <UP> or <DOWN> for Off or “bL.1” for On. Auto means the LCD backlight only lights when a menu is accessed, off means it never lights and on means it is always on. The backlight will be On during warm-up and Auto-zero modes.

<MENU>

Press to exit the User Menu and return to normal operation.

## PNEUMATIC CONNECTIONS

The two pressure ports on the enclosure are labeled High and Low. The output signal reads a positive value when the port pressure is higher on the High port than the Low port so ensure these ports are connected correctly. Use 1/8" to 3/16" ID flexible tubing for the pressure connections. A flexible silicone tube is recommended. Arrange the tubing to minimize stress on the connections and ensure there are no kinks in the tubing. For most accurate measurements, do not leave the Low port open to the atmosphere, run a return line from the Low port to the vicinity of the point being measured. See Figure 8.

## NORMAL OPERATION

During normal mode the device reads the pressure sensor and calculates the pressure value depending on the device model range and the selected pressure range. The pressure value is then displayed on the LCD and set as the output value for the analog output. The output value is updated once per second.

The output value may be affected by device settings such as the pressure averaging time. The pressure averaging setting controls how many readings are averaged to form the output value. For example, if the pressure averaging value is set to 30 seconds then 30 one-second readings are stored and averaged to form the output value. The next second will add a new reading and delete the first to form a new 30 second average for output. So the output gets updated every second with a new average reading.

On start-up when the first readings are obtained, the device averages the collected data as necessary until the required setting is reached. For example, if only 10 readings are available and the pressure averaging setting is 60 seconds then the output value is calculated as the average of those 10 readings. The next output value will be an average of 11 readings. This short-averaging will continue until the averaging setting is reached and then the output value will always be the average of 60 readings. If the averaging value is changed during operation, this process can be repeated for the new setting.

The averaging value can be set from 1 to 60 seconds via the User Menu.

During normal mode, the device also compares the output pressure value to the alarm setpoints and takes appropriate action. If the pressure value exceeds the setpoints then an alarm condition is set and the device will operate in alarm mode. Alarm mode activation is controlled by certain delay times and user settings described later.

During normal mode, the device also monitor the <UP>, <DOWN> and <MENU> keys and takes appropriate action. The keys are used for factory configuration, factory calibration and user setup.

The device also monitors a Volt/mA switch and determines the appropriate output scaling. The voltage span may be set via the User Menu to either 0-5 Vdc or 0-10 Vdc.

## ALARM MODE

The relay alarm feature is optional.

The alarm mode has several settings that are controlled by the User Menu. The device has both high and low alarms with setpoints set via the User Menu. The alarm setpoints can be set over the entire pressure range with some conditions.

The relay alarm option operates as follows. High and Low setpoints can be set via the User Menu from the minimum to the maximum pressure of the selected range, either 0-MAX or -MAX to +MAX, depending on the current setting. When the input pressure exceeds the setpoint for the on delay time, then the relay contacts will close. When the input pressure decreases below the setpoint for the off delay time then the relay contacts will open again.

The alarm on and off delay times can be set from 1 to 59 seconds or 1 to 10 minutes via the User Menu. For an alarm condition to be set the pressure value must exceed the alarm setpoint for more than the alarm on delay time. For an alarm condition to be reset the pressure value must return to a non-alarm value for more than the alarm off delay time. When the alarm condition is set the relay output will activate.

# AUTO ZERO MODE

A sensor auto zero can be initiated by pressing and holding the internal <Auto-Zero> switch for at least 3 seconds. If both pressure ports are close to zero pressure, then the device will calibrate with a new zero point. The auto zero can also be initiated by holding the ZERO IN terminal low for 3 seconds.

## SPECIFICATIONS

### SENSOR

- Accuracy ..... ±1% F.S. of selected range @ 22°C (72°F) including hysteresis, non-linearity and repeatability
- Pressure Ranges..... **UPB1A:** ±1", 0-1", ±0.5", 0-0.05" WC, ±250, 0-250, ±125, 0-125 Pa  
**UPB2A:** ±0.25", 0-0.25", ±0.125", 0-0.125" WC, ±60, 0-60, ±30, 0-30 Pa
- Stability ..... ±1% F.S. (1 year)
- Thermal Effect..... ±2% F.S. max, 10 to 40°C (50 to 104°F)
- Response Time ..... 1-60 seconds, (menu selectable)
- Proof Pressure..... **UPB1:** 100 "wc (24.9 kPa)  
**UPB2:** 40 "wc (9.96 kPa)
- Burst Pressure ..... **UPB1:** 200 "wc (49.8 kPa)  
**UPB2:** 80 "wc (19.9 kPa)
- Operating Conditions ..... 0 to 60°C (32 to 140°F), 0-95 %RH non-condensing
- Media Compatibility..... Dry air or inert gas
- Zero Adjust ..... Pushbutton or digital input auto-zero

### POWER SUPPLY

- Power Supply ..... 24 Vac/dc ±10%
- Power Consumption ..... 37 mA max. with relay option
- Input Voltage Effect ..... Negligible over specified operating range
- Protection Circuitry..... Reverse voltage protected and output limited

### OUTPUT

- Output Signal..... **3 wire:** 4-20 mA, 0-5 or 0-10 Vdc, field selectable
- Output Drive ..... **4-20 mA:** 750 Ω max  
**Voltage:** 2K Ω min

### LCD

- Display Size..... 38.1 x 16.5 mm (1.5" x 0.65")
- Digit Height..... 11.43 mm (0.45")
- Symbols ..... "WC, Pa
- Backlight..... Enable/disable/auto

### ALARM FUNCTIONS

- Alarm Relay Output ..... N.O. contact, 2 Amps @ 120 Vac or 30 Vdc
- Alarm Relay Trip Point..... Upper and Lower alarms adjustable over pressure range
- Alarm Relay Delay ..... 0 to 10 minutes via keypad

### GENERAL

- Storage Temperature ..... -40 to 95°C (-40 to 203°F)
- Wiring Connections..... Screw terminal block (14 to 22 AWG)
- Pressure Connections ..... 6.35 mm (0.25") Nylon barb fitting for 3.175 mm (0.125") to 4.762 mm (0.1875") ID tubing
- Conduit Connection..... Access hole for 1/2" NPT conduit or cable gland
- Enclosure ..... Polycarbonate, UL94-V0, IP65 (NEMA 4X)  
F style includes thread adapter (1/2" NPT to M16) and cable gland fitting
- Approvals..... CE, RoHS
- Country of Origin..... Canada

## DIMENSIONS

