

Description

The Ultra Low Pressure Transducer is used to measure differential pressure up to 1"wc or 250 Pa. It combines precision high sensitivity silicon sensing capabilities and the latest ASIC technology to substantially reduce offset errors due to changes in temperature, stability to warmup, long term instability and position sensitivity. It is ideal for monitoring pressure for air or other clean inert gas. It features bi-directional pressure measurement, an on-board auto-zero function, a backlit LCD to display the pressure value and an alarm relay with variable trip points. The device is field-configurable via the local menu or the BACnet connection.

Before Installation

Read these instructions carefully before installing and commissioning the ULP Pressure Transducer. Failure to follow these instructions may result in product damage. Do not use in an explosive or hazardous environment, with combustible or flammable gases, as a safety or emergency stop device or in any other application where failure of the product could result in personal injury. Take electrostatic discharge precautions during installation and do not exceed the device ratings.

Mounting

Mount the device using the four holes on the base of the unit. Leave enough space around the unit to connect the pressure tubing and avoid locations with severe vibrations, excessive moisture or rapid temperature changes. It should be mounted on a vertical surface with the pressure ports on the bottom and the cable entrance on the right. The enclosure has a standard ½” conduit opening and may be installed with either conduit and a conduit coupler or a cable gland type fitting. Open the hinged cover by releasing the latch and connect the device according to the wiring instructions. After wiring and setup are complete, close and latch the cover. The cover may be secured with two self-tapping screws in the holes provided.

Setup

The device parameters must be set before connection to the network and will ensure that each device has a unique MAC address and Device Instance for startup. On startup, the MAC address is appended to the Device Object : Vendor Identifier to create the unique Device Instance (Device Object : Object Identifier). Once connected to a network, the Device Object : Object Identifier can be written to any unique value via BACnet and then the MAC address will no longer be appended to the value. All parameters are saved in memory. The local menu and LCD are used to set the BACnet MAC device address (0-127) and the baud rate. The factory defaults are address 3 and 9600 baud. The menu and setup procedure is described later.

Wiring Instruction

The device has standard screw block connectors. Use shielded twisted pair wiring of at least 22 AWG for all connections and do not run device wires in the same conduit with wiring used to supply inductive loads such as motors. Disconnect the power supply before making any connections to prevent electrical shock or equipment damage. Make all connections in accordance with national and local electrical codes.

Connect the positive dc or the ac voltage hot side (24 Vac/dc ± 10%) to the **POWER** terminal. The supply common is connected to the **COMMON** terminal. The device is reverse voltage protected and will not operate if connected backwards. Use caution if 24 Vac power is used and one side of the transformer is earth-grounded. In general, the transformer should NOT be connected to earth ground when using devices with RS-485 network connections.

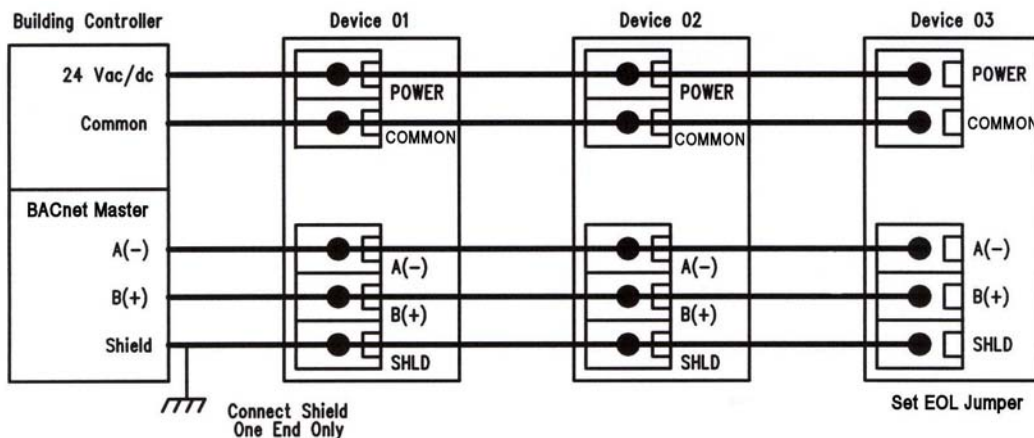

Connect the RS-485 network with twisted shielded pair to the terminals marked **A(-)**, **B(+)** and **SHIELD**. The positive wire connects to **B(+)** and the negative wire connects to **A(-)** and the cable shield must be connected to the **SHIELD** terminal on each device. If the device is installed at either end of an RS-485 network, an end-of-line (EOL) termination resistor (121 ohm) should be installed in parallel to the A(-) and B(+) terminals. This device includes a network termination jumper and will connect the 121 ohm resistor correctly on the pcb. Simply move the jumper to the EOL position and no external resistor is required. The ground wire of the shielded pair should be connected to earth ground at one end of the network. Do not run bus wiring in the same conduit as line voltage wiring or other wiring that switches power to highly inductive loads such as contactors, coils or motors.

A network segment is a single shielded wire loop run between several devices (nodes) in a daisy chain configuration. The total segment length should be less than 4000 feet (1220 meters) and the maximum number of nodes on one segment is 127. Nodes are any device connected to the loop and include controllers, repeaters and sensors such as the ULP but do not include the EOL terminators. To install more than 127 devices, or to increase the network length, repeaters will be required for proper communication. The maximum daisy chain length (segment) depends on transmission speed (baud rate), wire size and number of nodes. If communication is slow or unreliable, it may be necessary to wire two daisy chains to the controller with a repeater for each segment.

The **RELAY** output is a normally open dry contact. This signal can be used to directly control an alarm, ventilation fan or may be connected to a digital input of the BAS for status monitoring. Ensure any loads connected to the relay are within the relay rating in the Specification section.

Pneumatic Connections

The two pressure ports on the enclosure are labeled **High** and **Low**. The output value is positive when the port pressure is higher on the **High** port than the **Low** port so ensure these ports are connected correctly. Use 1/8" to 3/16" ID flexible tubing for the pressure connections. A flexible silicone tube is recommended. Arrange the tubing to minimize stress on the connections and ensure there are no kinks in the tubing. For most accurate measurements, do not leave the **Low** port open to the atmosphere, run a return line from the **Low** port to the vicinity of the point being measured.

Ensure the tubing to be used is clean and do not allow material to fall into the pressure ports as contamination could damage the sensor. When removing tubing use care to avoid breaking the ports. In some cases it is better to cut the tubing off rather than pulling it off but be careful not to cut the fitting or an air leak may occur.

Power Up Instruction

Before turning on the power, verify all wiring to ensure that it complies with the wiring diagram. Also, review the specifications to ensure the power supply is correct and that the pressure is within the correct range. The product should be allowed to warm-up for several minutes before attempting to verify accuracy. Allow the device to operate for 20 minutes before any calibration is performed.

Upon applying power to the device the alarm condition is set to off and communication is disabled. The LCD will display the software version number such as 1.03 for 5 seconds. All keys are disabled during start-up mode. At the end of the start-up mode the device will enter normal operation.

Normal Operation

The device has a bipolar pressure range (± 1 "wc for example) so the pressure applied to the **High** port should be higher than pressure applied to the **Low** port for a positive output response. Differential pressure is measured using both ports. If the **High** port has a positive pressure with respect to the **Low** port, then the output indicates a positive pressure. Negative pressure is indicated if the **High** pressure is less than the **Low** pressure.

During normal operation the device reads the pressure sensor and calculates the pressure value depending on the device model range. The pressure value is displayed on the LCD and sent to the pressure object.

The output value may be affected by the pressure averaging time setting in the menu. The pressure averaging setting controls how many readings are averaged to form the output value. The pressure averaging time defaults to 5 seconds and can be set from 1 to 60 seconds. This value effectively filters the output to prevent noise and false alarms.

The device also compares the output pressure value to the alarm setpoints and takes appropriate action. If the pressure value exceeds either setpoint then an alarm condition is set and the device will operate in alarm mode. Alarm mode activation is controlled by certain delay times and user settings described later. The device also monitors the keys and takes appropriate action if a key is pressed. The installer can enter the setup menu by pressing the <MENU> key at any time.

Alarm Operation

The alarm feature includes an on-board control relay and appropriate BACnet objects.

The alarm feature has several settings that can be controlled by the setup menu or via BACnet. The device has two alarm trip points designated the high pressure alarm limit and the low pressure alarm limit. The high pressure alarm defaults to 50% of the maximum pressure range and the low pressure alarm defaults to 50% of the minimum pressure range. For example, if the device has a ± 1 "wc range, then the default low pressure alarm limit will be -0.5 "wc and the default high pressure alarm limit will be +0.5 "wc. This is the same result for Pa ranges.

The alarm setpoints can be set over the pressure range with certain conditions. For this example the pressure range is ± 1 "wc.

- the low pressure alarm limit cannot go below the minimum pressure range setting (-1.0 "wc).
- the high pressure alarm limit cannot go above the maximum pressure range setting (+1.0 "wc).
- the high pressure alarm limit must always be greater than the low pressure alarm limit.
- the minimum alarm span (high alarm - low alarm) must be at least 25% of the pressure span (2 "wc x 25% = 0.5 "wc).
- if the minimum span is reached while adjusting one of the alarm limits, then the other alarm limit will be "pushed".

In this example for the ± 1 "wc range, these are some possible alarm settings: -1.0 to -0.5 "wc, -0.75 to -0.25 "wc, -0.5 to 0 "wc, -0.25 to 0.25 "wc, 0 to 0.5 "wc, 0.5 to 1.0 "wc.

The alarm also has settings for on delay and off delay which can be set via the menu or BACnet. Both of these default to 5 seconds but may be changed from 1-59 seconds or 1-10 minutes. For an alarm condition to be set the pressure value must exceed either alarm trip point for more than the alarm on delay time. For an alarm condition to be reset the pressure value must return to a non-alarm value for more than the alarm off delay time.

When an alarm condition is set the relay output will activate. If the alarm condition is reset the relay output will de-activate. The alarm can be disabled via the menu or BACnet and no alarm will be activated.

Auto Zero Operation

A sensor auto zero can be initiated by pressing and holding the internal auto zero switch for at least 3 seconds. If both pressure ports are close to zero pressure (open to ambient), then the device will calibrate with a new zero point. The auto zero can also be initiated via BACnet. The device must be in the normal operating mode and close to zero differential pressure for the auto zero to initiate.

Generally, it is not recommended that a span calibration be performed in the field unless a high quality calibrator with low differential pressure ranges is available and the temperature of the sensor can be maintained. Contact the factory for information on this type of calibration.

Setup Menu Operation

The Setup Menu can be accessed by pressing the internal <MENU> key at any time after the start-up mode.

The system suspends operation when in the menu and holds the last pressure value as the output value. If an alarm condition was present then it will be reset to enter the menu and alarm operation is disabled while in the menu (except for alarm test). If the Setup menu is not active for 5 minutes (no key press), then the menu will exit and the device returns to normal operation.

The Setup menu operation and parameters are explained below.

<MENU> Press and release the <MENU> key to enter the Setup Menu

1.  "wc, Pa The pressure scale defaults to "wc. Use <UP> or <DOWN> to toggle it to Pa. Press <MENU> to save the setting and advance the menu.

<MENU>

2.  1-60" The pressure averaging time defaults to 5 seconds. This can be changed from 1-60 seconds using <UP> or <DOWN>. Press <MENU> to save the setting and advance the menu.

<MENU>

3.  On, OFF The alarm enable/disable defaults to enable (On). The alarm can be disabled here. Use <UP> or <DOWN> to disable (OFF) the alarm. If the alarm is disabled, no alarm condition will be set. Note if the alarm is disabled, then none of the alarm settings will be shown in the menu.

<MENU>

4.  x.xx, xxx The high pressure alarm limit defaults to 75% of the range. This equals + 0.5 for the ± 1 "wc range, + 125 for the ± 250 Pa range, etc. It can be changed using <UP> or <DOWN> throughout the range. Resolution for each range is ± 1 "wc (0.05), ± 0.25 "wc (0.01), ± 250 Pa (10) and ± 60 Pa (2). Note that the ± 250 Pa range must be displayed as /10 such that it is - 25H to 25H.

<MENU>

5.  x.xx, xxx The low pressure alarm limit defaults to 25% of the range. This equals - 0.5 for the ± 1 "wc range, - 125 for the ± 250 Pa range, etc. It can be changed using <UP> or <DOWN> throughout the range. Resolution for each range is ± 1 "wc (0.05), ± 0.25 "wc (0.01), ± 250 Pa (10), ± 60 Pa (2). Note that the ± 250 Pa range must be displayed as /10 such that it is - 25H to 25H.

<MENU>

6.  1-59", 1-10' The alarm on delay defaults to 5" (seconds). It can be changed from 1-59" (seconds) and 1-10' (minutes) using <UP> or <DOWN>.

<MENU>

7.  1-59", 1-10' The alarm off delay defaults to 5" (seconds). It can be changed from 1-59" (seconds) and 1-10' (minutes) using <UP> or <DOWN>.

<MENU>

8. OFF, On The alarm test defaults to OFF. It can be set to On using <UP> or <DOWN>. This forces the relay to activate.



<MENU>

9. 0-127 The default BACnet MAC address is 3. This can be changed from 0 to 127 using <UP> and <DOWN>.



<MENU>

10. 96, 192, 384, 768 The default network baud rate is 96 (9600). It can be changed to 192 (19200), 384 (38400) or 768 (76800) using <UP> or <DOWN>.



<MENU> Exits the Setup Menu and returns to normal operation.

Note the LCD backlight can be turned on or off with the pcb jumper.

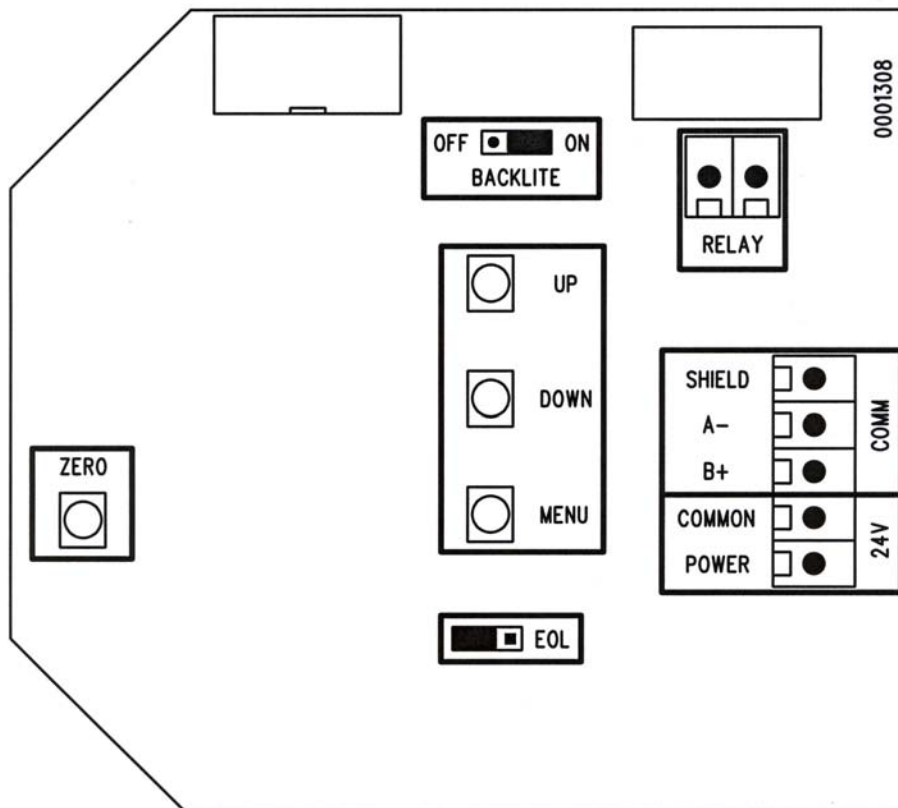

Specifications

Pressure Ranges ULP01 ± 1 "wc or ± 250 Pa
 ULP02 ± 0.25 "wc or ± 60 Pa

Accuracy ± 1% FS of selected range
 Stability ± 1% FS (1 year)
 Thermal Effect ± 2% FS max , 10 - 40 °C (50 - 104 °F)
 Response Time 1 - 60 Seconds (selectable)
 Proof Pressure 100 "wc (24.9 kPa) for ULP01, 40 "wc (9.96 kPa) for ULP02
 Burst Pressure 200 "wc (49.8 kPa) for ULP01, 80 "wc (19.9 kPa) for ULP02
 Operating Conditions 0 - 60 °C (32 - 140 °F), 0 - 90 %RH non-condensing
 Storage Temperature -40 - 95 °C (-40 - 203 °F)
 Media Compatibility Dry air or inert gas
 Zero Adjust Pushbutton or BACnet auto-zero

Power Supply 24 Vac/dc ± 10%
 Power Consumption 50 mA max
 Communication 2-wire RS-485, BACnet MS/TP protocol
 Baud Rate Locally set to 9600, 19200, 38400 or 76800
 MAC Address Range Locally set to 0-127 (factory default is 3)

Display 3 ½ digit LCD, 0.45" digit height, unit symbols and backlight
 Alarm Relay NO contact, 2 Amps @ 120 Vac or 30 Vdc
 Alarm Trip Point Upper and Lower alarms adjustable over the pressure range
 Alarm Delay 0 to 10 Minutes (selectable)

Wiring Connections Screw terminal block (14 to 22 AWG)
 Pressure Connections Barbed ports for 1/8" to 3/16" ID tubing
 Conduit Connection Access hole for ½" NPT conduit or cable gland
 Enclosure Grey ABS with gasket, UL94-5VB
 5.7" W x 4.0" H x 2.5" D (145mm x 101mm x 63mm)
 Weight 260 g (9.2 oz)

BACnet Object List

Object Type	Dynamically Creatable	Dynamically Deletable	Object Identifier	Object Name
Device	No	No	381003	Ultra Low Pressure 003
Analog Input	No	No	AI 1	Pressure Sensor Value
Analog Value	No	No	AV 1 AV 2 AV 3 AV 4 AV 5	Pressure Averaging Time Alarm High Limit Alarm Low Limit Alarm On Delay Alarm Off Delay
Binary Value	No	No	BV 1 BV 2 BV 3 BV 4	Alarm Enable Alarm Test Pressure Units Auto Zero
Binary Input	No	No	BI 1 BI 2 BI 3	Alarm Status Low Alarm Status High Alarm Status

The **BACnet Device object** allows configuration of the ULP device. Device object properties are shown below.

Property	Default Value	Property Data Type	Access
Object Identifier	381003	BACnetObjectIdentifier(numeric)	Read / Write
Object Name	Ultra Low Pressure 003	CharacterString (32)	Read / Write
Object Type	DEVICE (8)	BACnetObjectType	Read
System Status	OPERATIONAL (0)	BACnetDeviceStatus	Read
Vendor Name	Greystone Energy Systems	CharacterString	Read
Vendor Identifier	381	Unsigned16	Read
Model Name	ULP	CharacterString	Read
Firmware Revision	1.4	CharacterString	Read
Application Software Version	V1.0	CharacterString	Read
Location	150 English Dr, Moncton, NB	CharacterString (32)	Read / Write
Description	Greystone ULP Monitor	CharacterString (32)	Read / Write
Protocol Version	1	Unsigned	Read
Protocol Revision	14	Unsigned	Read
Protocol Services Supported	See description below	BACnetServicesSupported	Read
Protocol Object Types Supported	See description below	BACnetObjectTypesSupported	Read
Object List	See description below	BACnetArray	Read
Maximum APDU Length Accepted	50, B'0000'	Unsigned	Read
Segmentation Supported	NO_SEGMENTATION (3)	BACnetSegmentation	Read
APDU Timeout	6,000	Unsigned	Read / Write
Number of APDU Retries	3	Unsigned	Read / Write
Max Master	127	Unsigned	Read / Write
Max Info Frames	1	Unsigned	Read
Device Address Binding	Empty	BACnetAddressBinding	Read
Database Revision	0	Unsigned	Read
Property List		BACnetArray	Read

Object_Identifier Initial default number is 381003, where 381 is the vendor ID and 003 is the default network MAC address. When the MAC address is initially changed the value is updated and saved. For example, if the MAC address is set to 50 via the menu for startup, then the device instance will be set to 381050. This property is also writable via BACnet. If the Device:Object_Identifier is written to via BACnet then the MAC address is no longer appended to the vendor ID to create this value.

Object_Name Initial string is “Ultra Low Pressure 003” where 003 is the default network address. Can be written with a new string of maximum length of 32 characters and the value is saved. The “003” is the MAC address as set by the menu and is automatically changed if the MAC address is changed. Once written to via BACnet, the MAC address no longer gets appended to the value.

Protocol_Services_Supported readProperty, writeProperty, deviceCommunicationControl, who-Has, who-Is
Binary bit string = {00000000 00001001 01000000 00000000 01100000 0}

Protocol_Object_Types_Supported Analog_Input, Analog_Value, Binary_Input, Binary_Value, Device
Binary bit string = {10110100 10000000 00000000 00000000 00000000 00000000 00000000}

Object_List ((Device, Instance 3), (Analog Input, Instance 1), (Analog Value, Instance 1) ... (Analog Value, Instance 5)
(Binary Value, Instance 1) (Binary Value, Instance 4), (Binary Input, Instance 1).....(Binary Input, Instance 3)

APDU_Timeout Value is 6,000. Can be modified from 1 to 10,000.

Number_Of_APDU_Retries Value is 3. Can be modified from 1 to 10.

Max_Master Value is 127. Value is saved. Can be modified from 1 to 127.

Database_Revision Value is 0 to 255.

The analog input BACnet object allows reading of current pressure sensor value. AI object properties are shown below.

Analog input object Pressure Sensor Value (Present_Value is current sensor reading in the current units.)

Property	Default Value	Property Data Type	Access
Object Identifier	AI1 (Analog Input 1)	BACnetObjectIdentifier	Read
Object Name	Pressure Sensor Value	CharacterString (32)	Read
Object Type	ANALOG_INPUT (0)	BACnetObjectType	Read
Present Value	current reading	Real	Read
Description	Pressure Value in Pa or "wc	CharacterString (32)	Read
Device Type	Ultra Low Pressure Sensor	CharacterString (32)	Read
Status Flags	{false, false, false, false} (0000)	BACnetStatusFlags	Read
Event State	NORMAL (0)	BACnetEventState	Read
Reliability	NO_FAULT_DETECTED (0)	BACnetReliability	Read
Out of Service	FALSE (0)	Boolean	Read
Units	Pascals (53) or "wc (58)	BACnetEngineeringUnits	Read
Property List		BACnetArray	Read

The five analog value BACnet objects allow configuration of the alarms, etc. AV object properties are shown below.

Analog value object Pressure Averaging Time (Present_Value defaults to 5 seconds. Can be set from 1 to 60 seconds. Resolution is 1 sec)

Property	Default Value	Property Data Type	Access
Object Identifier	AV1 (Analog Value 1)	BACnetObjectIdentifier	Read
Object Name	Pressure Averaging Time	CharacterString (32)	Read
Object Type	ANALOG_VALUE (2)	BACnetObjectType	Read
Present Value	5	Real	Read / Write
Description	Pressure Averaging Time (1-60 seconds)	CharacterString (32)	Read
Status Flags	{false, false, false, false} (0000)	BACnetStatusFlags	Read
Event State	NORMAL (0)	BACnetEventState	Read
Out of Service	FALSE (0)	Boolean	Read
Units	Seconds (73)	BACnetEngineeringUnits	Read
Property List		BACnetArray	Read

Analog value object Alarm High Limit (Present_Value defaults to (range x 75%)).

Property	Default Value	Property Data Type	Access
Object Identifier	AV2 (Analog Value 2)	BACnetObjectIdentifier	Read
Object Name	Alarm High Limit	CharacterString (32)	Read
Object Type	ANALOG_VALUE (2)	BACnetObjectType	Read
Present Value	0.5 (for example)	Real	Read / Write
Description	Alarm High Limit in Pa or "wc	CharacterString (32)	Read
Status Flags	{false, false, false, false} (0000)	BACnetStatusFlags	Read
Event State	NORMAL (0)	BACnetEventState	Read
Out of Service	FALSE (0)	Boolean	Read
Units	Pascals (53) or "wc (58)	BACnetEngineeringUnits	Read
Property List		BACnetArray	Read

Analog value object Alarm Low Limit (Present_Value defaults to (range x 25%)).

Property	Default Value	Property Data Type	Access
Object Identifier	AV3 (Analog Value 3)	BACnetObjectIdentifier	Read
Object Name	Alarm Low Limit	CharacterString (32)	Read
Object Type	ANALOG_VALUE (2)	BACnetObjectType	Read
Present Value	-0.5 (for example)	Real	Read / Write
Description	Alarm Low Limit in Pa or "wc	CharacterString (32)	Read
Status Flags	{false, false, false, false} (0000)	BACnetStatusFlags	Read
Event State	NORMAL (0)	BACnetEventState	Read
Out of Service	FALSE (0)	Boolean	Read
Units	Pascals (53) or "wc (58)	BACnetEngineeringUnits	Read
Property List		BACnetArray	Read

Analog value object Alarm On Delay (Present_Value defaults to 5 seconds. Can be set from 1 to 600 seconds).

Property	Default Value	Property Data Type	Access
Object Identifier	AV4 (Analog Value 4)	BACnetObjectIdentifier	Read
Object Name	Alarm On Delay	CharacterString (32)	Read
Object Type	ANALOG_VALUE (2)	BACnetObjectType	Read
Present Value	5	Real	Read / Write
Description	Alarm On Delay (1-600 seconds)	CharacterString (32)	Read
Status Flags	{false, false, false, false} (0000)	BACnetStatusFlags	Read
Event State	NORMAL (0)	BACnetEventState	Read
Out of Service	FALSE (0)	Boolean	Read
Units	Seconds (73)	BACnetEngineeringUnits	Read
Property List		BACnetArray	Read

Analog value object Alarm Off Delay (Present_Value defaults to 5 seconds. Can be set from 1 to 600 seconds).

Property	Default Value	Property Data Type	Access
Object Identifier	AV5 (Analog Value 5)	BACnetObjectIdentifier	Read
Object Name	Alarm Off Delay	CharacterString (32)	Read
Object Type	ANALOG_VALUE (2)	BACnetObjectType	Read
Present Value	5	Real	Read / Write
Description	Alarm Off Delay (1-600 seconds)	CharacterString (32)	Read
Status Flags	{false, false, false, false} (0000)	BACnetStatusFlags	Read
Event State	NORMAL (0)	BACnetEventState	Read
Out of Service	FALSE (0)	Boolean	Read
Units	Seconds (73)	BACnetEngineeringUnits	Read
Property List		BACnetArray	Read

The 4 binary value BACnet objects allow device parameter setting. Binary value object properties are shown below.

Binary value object Alarm Enable (Present_Value is normally 1, set to 0 to disable the alarm functions)

Property	Default Value	Property Data Type	Access
Object Identifier	BV1 (Binary Value 1)	BACnetObjectIdentifier	Read
Object Name	Alarm Enable	CharacterString (32)	Read
Object Type	BINARY_VALUE (5)	BACnetObjectType	Read
Present Value	ACTIVE (1)	BACnetBinaryPV	Read / Write
Description	0 = Alarm Disable, 1 = Alarm Enable	CharacterString (32)	Read
Status Flags	{false, false, false, false} (0000)	BACnetStatusFlags	Read
Event State	NORMAL (0)	BACnetEventState	Read
Reliability	NO_FAULT_DETECTED (0)	BACnetReliability	Read
Out of Service	FALSE (0)	Boolean	Read
Property List		BACnetArray	Read

Binary value object Alarm Test (Present_Value is normally 0, set to 1 to test the alarm functions)

Property	Default Value	Property Data Type	Access
Object Identifier	BV2 (Binary Value 2)	BACnetObjectIdentifier	Read
Object Name	Alarm Test	CharacterString (32)	Read
Object Type	BINARY_VALUE (5)	BACnetObjectType	Read
Present Value	INACTIVE (0)	BACnetBinaryPV	Read / Write
Description	0 = Normal Operation, 1 = Alarm Test	CharacterString (32)	Read
Status Flags	{false, false, false, false} (0000)	BACnetStatusFlags	Read
Event State	NORMAL (0)	BACnetEventState	Read
Reliability	NO_FAULT_DETECTED (0)	BACnetReliability	Read
Out of Service	FALSE (0)	Boolean	Read
Property List		BACnetArray	Read

Note BV2 must be manually set back to 0 after the alarm test.

Binary value object Pressure Units (Present_Value is normally 0 for "wc pressure units, set to 1 for Pa units)

Property	Default Value	Property Data Type	Access
Object Identifier	BV3 (Binary Value 3)	BACnetObjectIdentifier	Read
Object Name	Pressure Units	CharacterString (32)	Read
Object Type	BINARY_VALUE (5)	BACnetObjectType	Read
Present Value	INACTIVE (0)	BACnetBinaryPV	Read / Write
Description	0 = "wc, 1 = Pa	CharacterString (32)	Read
Status Flags	{false, false, false, false} (0000)	BACnetStatusFlags	Read
Event State	NORMAL (0)	BACnetEventState	Read
Reliability	NO_FAULT_DETECTED (0)	BACnetReliability	Read
Out of Service	FALSE (0)	Boolean	Read
Property List		BACnetArray	Read

Binary value object Auto Zero (Present_Value is normally 0, set to 1 to perform a sensor zero calibration)

Property	Default Value	Property Data Type	Access
Object Identifier	BV4 (Binary Value 4)	BACnetObjectIdentifier	Read
Object Name	Auto Zero	CharacterString (32)	Read
Object Type	BINARY_VALUE (5)	BACnetObjectType	Read
Present Value	INACTIVE (0)	BACnetBinaryPV	Read / Write
Description	0 = Normal, 1 = Perform zero cal	CharacterString (32)	Read
Status Flags	{false, false, false, false} (0000)	BACnetStatusFlags	Read
Event State	NORMAL (0)	BACnetEventState	Read
Reliability	NO_FAULT_DETECTED (0)	BACnetReliability	Read
Out of Service	FALSE (0)	Boolean	Read
Property List		BACnetArray	Read

Note BV4 will reset to 0 after a few seconds. The device must be in the normal mode to have an effect.

The 3 binary input BACnet objects indicates the alarm status.

Binary input object Alarm Status (Present_Value is normally 0, will change to 1 if any alarm is present)

Property	Default Value	Property Data Type	Access
Object Identifier	BI1 (Binary Input 1)	BACnetObjectIdentifier	Read
Object Name	Alarm Status	CharacterString (32)	Read
Object Type	BINARY_INPUT (3)	BACnetObjectType	Read
Present Value	INACTIVE (0)	BACnetBinaryPV	Read
Description	Alarm Status	CharacterString (32)	Read
Device Type	0 = No Alarm, 1 = Pressure Alarm	CharacterString (32)	Read
Status Flags	{false, false, false, false} (0000)	BACnetStatusFlags	Read
Event State	NORMAL (0)	BACnetEventState	Read
Reliability	NO_FAULT_DETECTED (0)	BACnetReliability	Read
Out of Service	FALSE (0)	Boolean	Read
Polarity	NORMAL (0)	BACnetPolarity	Read
Property List		BACnetArray	Read

Binary input object Low Alarm Status (Present_Value is normally 0, will change to 1 if a low pressure alarm is present)

Property	Default Value	Property Data Type	Access
Object Identifier	BI2 (Binary Input 2)	BACnetObjectIdentifier	Read
Object Name	Low Alarm Status	CharacterString (32)	Read
Object Type	BINARY_INPUT (3)	BACnetObjectType	Read
Present Value	INACTIVE (0)	BACnetBinaryPV	Read
Description	Low Alarm Status	CharacterString (32)	Read
Device Type	0 = No Low Alarm, 1 = Low Alarm	CharacterString (32)	Read
Status Flags	{false, false, false, false} (0000)	BACnetStatusFlags	Read
Event State	NORMAL (0)	BACnetEventState	Read
Reliability	NO_FAULT_DETECTED (0)	BACnetReliability	Read
Out of Service	FALSE (0)	Boolean	Read
Polarity	NORMAL (0)	BACnetPolarity	Read
Property List		BACnetArray	Read

Binary input object High Alarm Status (Present_Value is normally 0, will change to 1 if a high pressure alarm is present)

Property	Default Value	Property Data Type	Access
Object Identifier	BI3 (Binary Input 3)	BACnetObjectIdentifier	Read
Object Name	High Alarm Status	CharacterString (32)	Read
Object Type	BINARY_INPUT (3)	BACnetObjectType	Read
Present Value	INACTIVE (0)	BACnetBinaryPV	Read
Description	High Alarm Status	CharacterString (32)	Read
Device Type	0 = No High Alarm, 1 = High Alarm	CharacterString (32)	Read
Status Flags	{false, false, false, false} (0000)	BACnetStatusFlags	Read
Event State	NORMAL (0)	BACnetEventState	Read
Reliability	NO_FAULT_DETECTED (0)	BACnetReliability	Read
Out of Service	FALSE (0)	Boolean	Read
Polarity	NORMAL (0)	BACnetPolarity	Read
Property List		BACnetArray	Read

BACnet Protocol Implementation Conformance Statement (PICS)

Date : May 4, 2016
Vendor Name : Greystone Energy Systems
Product Name : Ultra Low Pressure Transducer
Product Model Number : ULP
Application Software Version : 1.0
Firmware Revision : 1.4
BACnet Protocol Revision : 14

Product Description : The Greystone Ultra Low Pressure Transducer is a smart pressure sensor with native BACnet MS/TP protocol for network communication. It measures differential pressure levels and reports this value back to a building automation system (BAS). The device features an alarm function and has an LCD to display measured values.

BACnet Standardized Device Profile (Annex L) : BACnet Application Specific Controller (B-ASC)

BACnet Interoperability Building Blocks Supported (Annex K) : DS-RP-B, DS-WP-B,
 DM-DDB-B, DM-DOB-B
 DM-DCC-B

Segmentation Capability : Not supported

Standard Object Types Supported :

Object Type	Dynamically Creatable	Dynamically Deletable	Optional Properties Supported	Writable Properties
Device	No	No	Location, Description, Max_Master, Max_Info_Frames	Object_Identifier, Object_Name, Location, Description, APDU_Timeout, Max_Master, Number_Of_APDU_Retries
Analog Input	No	No	Description, Reliability, Device_Type	
Analog Value	No	No	Description	Present_Value
Binary Value	No	No	Description, Reliability	Present_Value
Binary Input	No	No	Description, Reliability, Device_Type	

Data Link Layer Options : MS/TP master (Clause 9), baud rates : 9600, 19200, 38400, 76800

Device Address Binding : Not supported

Networking Options : None

Character Set Supported : ISO 10646 (UTF-8)