

All Purpose Temperature Sensor

Installation Instructions

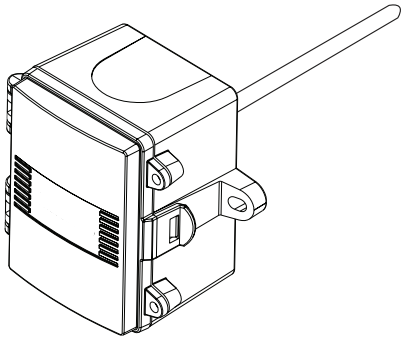

INTRODUCTION

The single point, all purpose duct/immersion temperature sensor utilizes a precision sensor that is encapsulated in 6 mm (0.236") OD, 304 series stainless steel probe and is available in various lengths. All probes provide excellent heat transfer, fast response and resistance to moisture penetration. A compact ABS enclosure with a hinged and gasketed cover is provided for ease of installation.

BEFORE INSTALLATION

Read these instructions carefully before installing and commissioning the temperature sensor. Failure to follow these instructions may result in product damage. Do not use in an explosive or hazardous environment, with combustible or flammable gases, as a safety or emergency stop device or in any other application where failure of the product could result in personal injury. **Do not exceed the device ratings.**

MOUNTING (DUCT)

The duct temperature sensor installs directly into any air duct with several lengths available for a wide range of duct widths/diameters. Please select a suitable installation area in the middle of the duct wall. To achieve the best reading, do not place in an area where air stratification may be present. Mount the sensor at least 1.5 m (5') in either direction from elbows, dampers, filters or other duct restrictions. Avoid areas where the sensor is exposed to vibrations or rapid temperature changes.

Once a suitable spot is selected, drill a 9.5 - 12 mm (3/8" - 1/2") hole for the probe.

Slide the probe in the drilled hole until the enclosure is flush against the duct. The airflow direction is not important. Secure the enclosure to the duct with (2) #10 x 25 mm (1") self tapping screws (not provided). Tighten screws until the enclosure is tight against the duct and ensure there is no movement of the enclosure as shown in Figure 1.

A foam gasket on the back of the enclosure provides a tight seal against any air leaks.

MOUNTING (IMMERSION)

The temperature sensor must be installed into a thermowell. Failure to use a thermowell will create leaks and could damage the sensor. Install the thermowell as recommended in Figure 2. For complete thermowell installation instructions, please refer to installation instructions provided with the thermowell.

It is recommended to use heat conductive compound. Prior to installing the sensor inject a liberal amount into the thermowell and/or on the tip of the sensor. Slide the probe into the thermowell until it makes contact with the bottom of the thermowell. Tighten the set screw to secure the probe in the thermowell. See Figure 3.

The enclosure has a hinged cover with a latch. Open the cover by pulling slightly on the latch on the right side of the enclosure. At the same time pulling on the cover, as illustrated in Figure 4.

A 1/2" NPT threaded connection hole is provided in the bottom of the enclosure. Screw the EMT connector or cable gland connector in until tight. See Figure 5. It is recommended that weatherproof conduit or cable gland fittings be used. The E style enclosure includes 1/2" NPT to M16 thread adapter and cable gland fitting.

Make wiring connections as per the "Wiring" illustrations on Page 2.

Swing door closed until securely latched. For added security, 2 screws are provided that may be installed in the integrated screw tabs. See Figure 6.

Figure 1

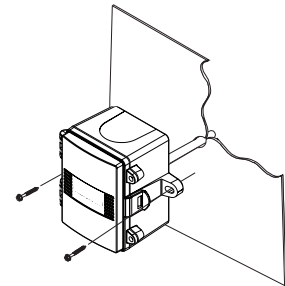

Figure 2

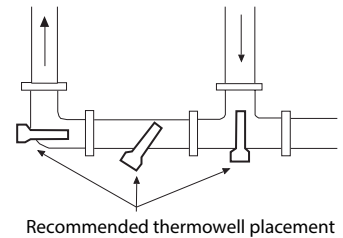

Figure 3

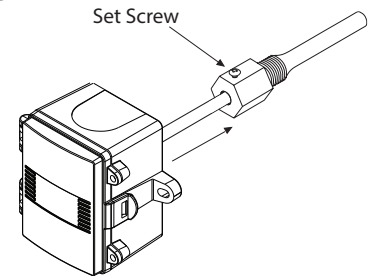

Figure 4

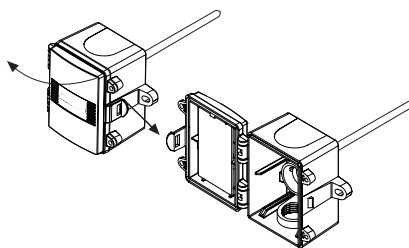

Figure 5

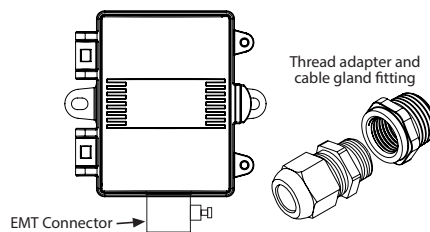
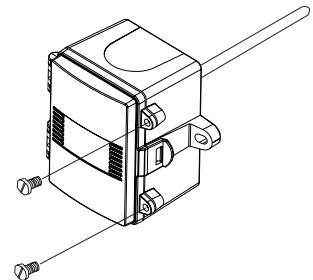
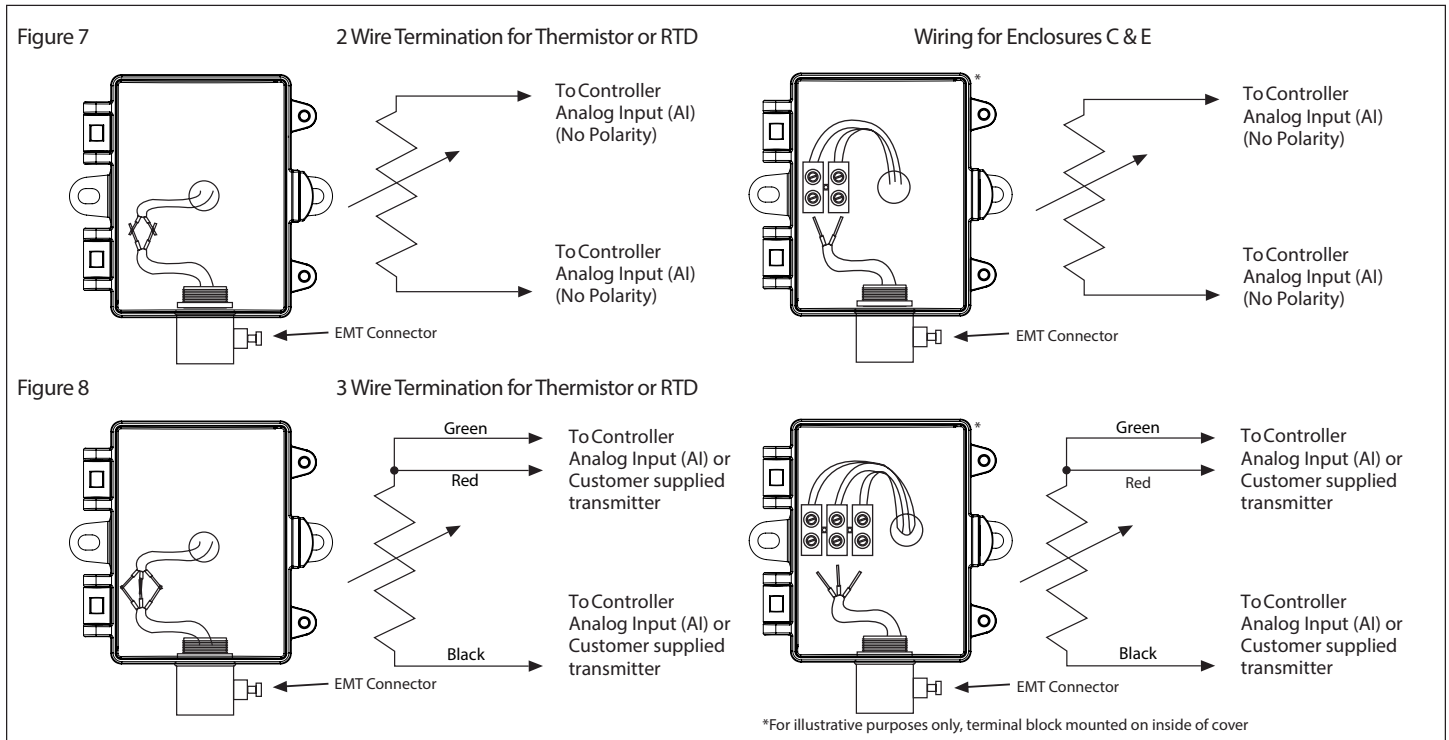

Figure 6



WIRING

- Use 18-24 AWG shielded wiring for all connections. Do not locate the device wires in the same conduit with wiring used to supply inductive loads such as motors. Make all connections in accordance with national and local codes.
- Pull at least six inches of wire into the enclosure, then complete the wiring connection according to the wiring diagrams below.
- All thermistors and most RTD's are a two wire hook up and are not polarity sensitive. See Figure 7.
- For RTD's that are 3 wire connection see Figure 8.



TYPICAL WIRE RESISTANCE VALUES

When using low resistance sensors, long wire runs can add significant error to the readings. Use the following chart to determine errors due to wire resistance or consider using a 1000 ohm sensor or a transmitter for better accuracy. Locate the type of wire being used. Multiply the total length of the wire (distance from the controller to the sensor and back) by the number found in the chart below for total resistance.

GAUGE WIRE TYPE	18 AWG	22 AWG	24 AWG
STRANDED (OHMS/FOOT)	5.85 mΩ	14.75 mΩ	23.29 mΩ
SOLID (OHMS/FOOT)	6.4 mΩ	15.85 mΩ	25.72 mΩ

SPECIFICATIONS:

Sensor Type:..... Various thermistors or RTD
 Sensor Accuracy:..... **Thermistors:** $\pm 0.2^{\circ}\text{C}$ ($\pm 0.36^{\circ}\text{F}$) @ 25°C (77°F)
Platinum RTD's: $\pm 0.3^{\circ}\text{C}$ ($\pm 0.54^{\circ}\text{F}$) @ 0°C (32°F)
Nickel RTD's: $\pm 0.4^{\circ}\text{C}$ ($\pm 0.72^{\circ}\text{F}$) @ 0°C (32°F)
 Probe Sensing Range: -40 to 100°C (-40 to 212°F)
 Ambient Operating Range:.... -40 to 60°C (-40 to 140°F)
 Wire Material:..... PVC insulated, parallel bonded, 22 AWG
 Probe Material:..... 304 Series stainless steel
 Probe Diameter:..... 6 mm (0.236")
 Standard lengths:..... 50, 100, 150, 200, 300, and 400 mm
 (2", 4", 6", 8", 12", and 18")
 Enclosure:..... ABS - UL94-V0, IP65 (NEMA4X)
 C - Terminal block
 E - includes thread adapter (1/2" NPT to M16), cable gland fitting, and terminal block
 Termination:..... A - pigtail, 2 or 3 wire
 C & E - Terminal block, 2 or 3 wire
 Approvals:..... CE & UL
 UL Ratings:..... **Standard:** UL 60730, CSA E60730 & UL 2043, CSA/ULC S142. Suitable for Use in Air Handling Spaces
Purpose of Control: Temperature Sensor
Pollution Degree: 2
Impulse Voltage: 330V
 Country of Origin:..... Canada

DIMENSIONS

