

High Accuracy Room Temperature Sensor

Installation Instructions

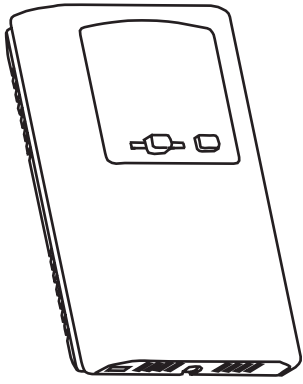

INTRODUCTION

The continental series is an attractive, low profile enclosure that incorporates a precision temperature sensor used to monitor room temperatures. Additional options are available that include set-point adjustment, manual override, fan speed, handset communication port, and LED indicator.

BEFORE INSTALLATION

Read these instructions carefully before installing and commissioning the device. Failure to follow these instructions may result in product damage. Do not use in an explosive or hazardous environment, with combustible for flammable gases, as a safety or emergency stop device or in any other

application where failure of the product could result in personal injury. Take electrostatic discharge precautions during installation. **Do not exceed the device ratings.**

MOUNTING

The temperature sensor mounts directly on a wall or onto an electrical wall box. For the most accurate results, units should be mounted on an inside wall to a wall box five feet from the floor. Do not mount the sensor near doors, opening windows, supply air diffusers, or other known air disturbances. Avoid areas where the sensor is exposed to vibrations or rapid temperature changes.

The cover is hooked to the base at the top edge and must be removed from the bottom edge first. Use a small Phillips screwdriver to loosen the security screw as shown in Figure 1. (Complete removal is not required). Use a screw driver to carefully pry each bottom corner if necessary. Tip the cover away from the base and sit it aside as shown in Figure 2.

The PCB must be removed from the base to access the mounting holes. Follow usual anti-static procedures when handling the PCB and be careful not to touch the sensors. The PCB is removed by pressing the enclosure base to unsnap the latch near the bottom edge, then the PCB can be lifted out of the base as shown in Figure 3.

Set the PCB aside until the base is mounted on the wall. For added protection, place the PCB in the supplied anti-static bag.

Mount the base by screwing it to an electrical box or directly to the wall as shown in Figure 4.

After the base is screwed to an electrical box or the wall using the appropriate holes, remove the PCB from the anti-static bag, feed connection wires through center hole and place the top of the PCB into the PCB holders on the backplate and snap the bottom of the PCB into place as shown in Figure 4.

Make wire connections as per the Wiring Illustrations on Page 2 and install decorative cover by placing the top of the cover into the cover holder on the top of the backplate and snapping the bottom into place as shown in Figure 4. Tighten security screw with a screwdriver.

Figure 1

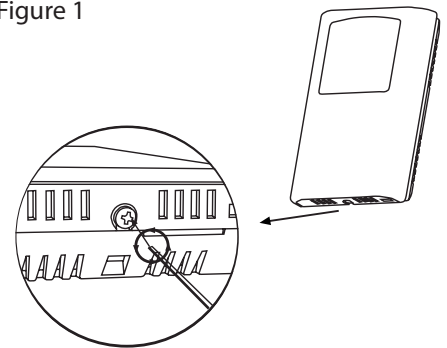

Figure 2

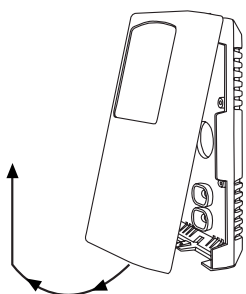

Figure 3

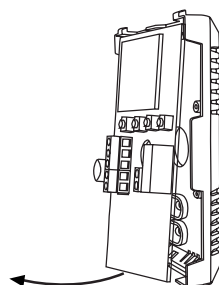
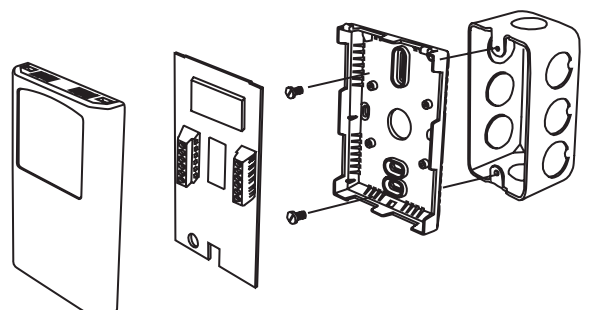

Figure 4



WIRING

- Deactivate the 24 Vac/dc power supply until all connections are made to the device to prevent equipment damage.
- Use 14-22 AWG shielded wiring for all connections and do not locate the device wires in the same conduit with wiring used to supply inductive loads such as motors. Make all connections in accordance with national and local codes.
- Pull at least six inches of control wire into the enclosure, then complete the wiring connection according to the wire diagram for the applicable power supply and output signal type as shown in Figure 5.
- Connect the DC positive or the AC voltage hot side to the PWR terminal. For voltage output or AC power, the supply Common is connected to the COM terminal. The device is reverse voltage protected and will not operate if connected backwards. It has a half-wave power supply so the supply Common is the same as the signal Common. See Figure 5.
- The analog output is available on the OUT terminal. Check the controller Analog Input to determine the proper connection before applying power as shown in Figure 5.
- Once all connections are made and checked, power can be applied.

The override switch output is a dry-contact and is available on the SWITCH + and SWITCH - terminals. It is typically connected to a low-voltage digital input on the controller to indicate room occupancy or override when the button is activated.

The resistive fan speed output signal is available on the FAN + and FAN - terminals and has five positions

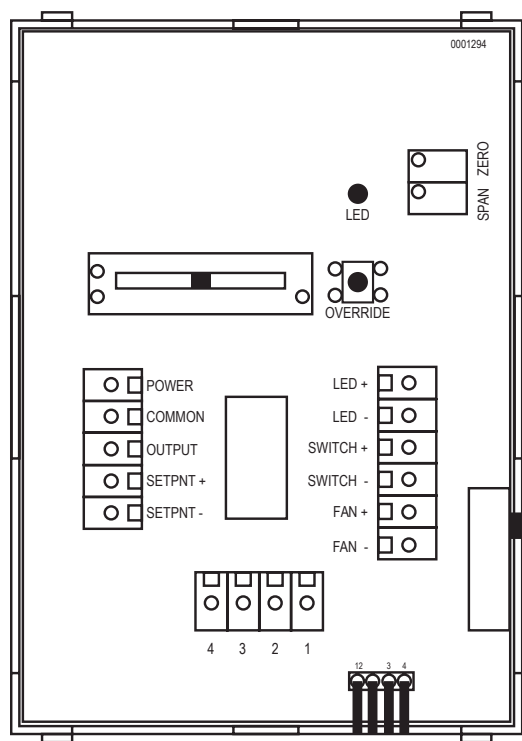
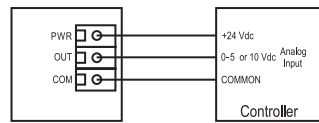

Figure 5

Transmitter Wiring to Controller

Wiring for 0-5 or 0-10 Vdc output signal and 24 Vdc power from controller



Wiring for 4-20 mA loop-powered output and external 24 Vdc power from controller

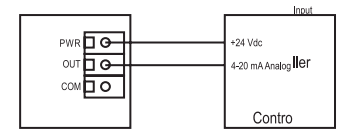

Wiring for 0-5 or 0-10 Vdc output signal and with external 24 Vdc power supply

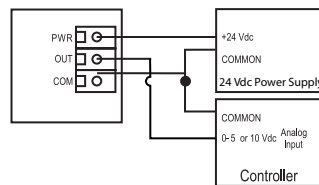

Wiring for 4-20 mA loop-powered output and external 24 Vdc power supply

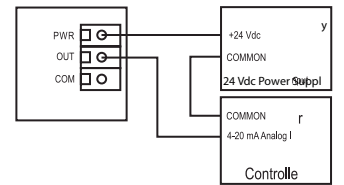

Wiring for all output signals with external 24 Vac power transformer

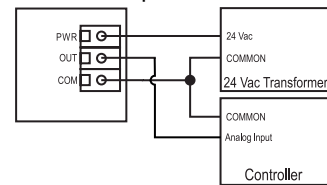
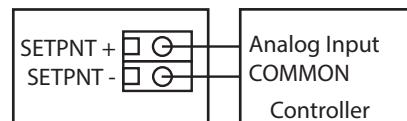
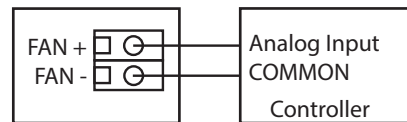
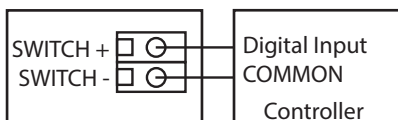
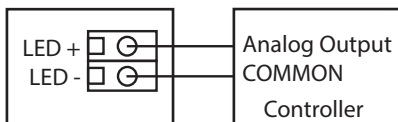

Figure 6



SPECIFICATIONS

GENERAL

Sensor.....	1000 Ω platinum RTD
Sensor Accuracy.....	RTD Class A: $\pm 0.15^{\circ}\text{C}$ ($\pm 0.27^{\circ}\text{F}$) @ 0°C (32°F) RTD 1/3 DIN: $\pm 0.1^{\circ}\text{C}$ ($\pm 0.18^{\circ}\text{F}$) @ 0°C (32°F) RTD 1/10 DIN: $\pm 0.03^{\circ}\text{C}$ ($\pm 0.054^{\circ}\text{F}$) @ 0°C (32°F)
Output Signal.....	4-20 mA current loop, 0-5 Vdc, or 0-10 Vdc (factory configured)
Transmitter Accuracy	$\pm 0.1\%$ of span, including linearity
4-20 mA loop power supply.....	15-35 Vdc or 20-26 Vac
Output Drive @ 24 Vdc:	Current: 600 Ω maximum Voltage: 10 K Ω minimum
Power Supply:.....	0-5 Vdc: 10-35 Vdc or 10-28 Vac 0-10 Vdc: 15-35 Vdc or 15-28 Vac 4-20 mA: 15-35 Vdc (Loop-powered) or 22-28 Vac
Current Consumption:.....	Current: 20 mA Voltage: 5 mA
Maximum Current (Voltage).....	5 mA nominal
Maximum Output (Voltage)	Limited to <5.5 Vdc for 0-5 Vdc, <10.5 for 0-10 Vdc
Input Voltage Effect.....	Negligible over specified operating range
RFI Rejection	Good RFI rejection of normal frequencies
Protection Circuitry.....	Reverse voltage protected and output limited
Operating Conditions	0 to 50°C (32 to 122°F), 0 to 95 %RH non-condensing
Wiring Connections.....	Screw terminal block (14 to 22 AWG)
Enclosure	White ABS, IP30 (NEMA 1) 84mm W x 119mm H x 29mm D (3.3" x 4.7" x 1.15")
Country of Origin.....	Canada

SET-POINT ADJUSTMENT

Type.....	Front panel slidepot, 2 wire resistance output
Range.....	0K to 10K Ω standard
Custom Spans Available	1K, 2K, 5K, 10K, or 20K Ω

MANUAL OVERRIDE

Type.....	Front panel, momentary push-button
Front Panel Push-Button.....	50 mA @ 12 Vdc, N.O., SPST

STATUS LED INPUT

Signal Type.....	Active high, low, or 2 wire, 5V current limited standard
LED Colors.....	Yellow (Y), Red (R), or Green (G)
Power Supply	5 Vdc standard, 10 or 24 Vdc optional

COMMUNICATION JACKS

Molex.....	4 pin header to 4 pin terminal block, requires HHTA - Hand Held Adapter
------------	--

FAN SPEED SWITCH

Type	Side mounted, 5 position slide switch
Designators	Off, Auto, Low, Medium, High
Signal	2 wire, resistance output, 0, 2, 4, 6, 8 K Ω custom ranges available, contact Greystone

DIMENSIONS

