

# High Accuracy Flexible Copper Duct Average Temperature Sensor

## Installation Instructions

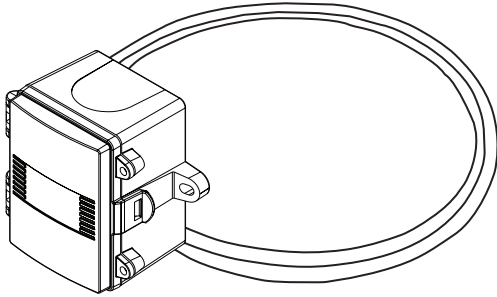

### INTRODUCTION

The high accuracy multi-point duct average temperature sensor utilizes several precision sensors spaced at equal distances and encapsulated in a 7.94 mm (0.3125") OD, soft copper probe and is available in various lengths. All probes provide excellent heat transfer, fast response and resistance to moisture penetration. A compact ABS enclosure with a hinged and gasketed cover is provided for ease of installation.

### BEFORE INSTALLATION

Read these instructions carefully before installing and commissioning the temperature sensor. Failure to follow these instructions may result in product damage. Do not use in an explosive or hazardous environment, with combustible or flammable gases, as a safety or emergency stop device or in any other application where failure of the product could result in personal injury. **Do not exceed the device ratings.**

### MOUNTING

The sensor installs directly into any air duct with several lengths available for a wide range of duct widths/diameters. Select a suitable installation area in the middle of the duct wall. To achieve the best reading, do not place in an area where air stratification may be present. Mount the sensor at least 1.5 m (5') in either direction from elbows, dampers, filters or other duct restrictions. Avoid areas where the sensor is exposed to vibrations or rapid temperature changes.

Once a suitable spot is selected, drill a 9.5 - 12 mm (3/8" - 1/2") hole. Uncoil the copper probe and slide into the drilled hole until the enclosure is flush against the duct. The airflow direction is not important. Secure the enclosure to the duct with #10 x 25 mm (1") self tapping screws (not provided). Tighten screws until the enclosure is tight against the duct and ensure that there is no movement of the enclosure as shown in Figure 1.

A foam gasket is provided on the back of the enclosure that provides a tight seal against any air leaks.

The probe can be easily shaped to fit any duct size but observe a minimum bend radius of 4" to prevent damage to the wire or sensors. Criss-cross the duct multiple times so that the probe covers a large section of the duct. The probe needs to be fastened onto hangers using tube clamps or wire ties. See Figure 2.

The enclosure has a hinged cover with a latch. Open the cover by pulling slightly on the latch on the right side of the enclosure, at the same time pulling on the cover, as illustrated in Figure 3.

A 1/2" NPT threaded connection hole is provided in the bottom of the enclosure. Screw the EMT connector or cable gland connector in until tight. See Figure 4. It is recommended that weatherproof conduit or cable gland fittings be used. E style enclosure includes 1/2" NPT to M16 thread adapter and cable gland fitting.

Make wiring connections as per the "Wiring" illustrations on Page 2.

Swing door closed until securely latched. For added security, 2 screws are provided that may be installed in the integrated screw tabs. See Figure 5.

Figure 1

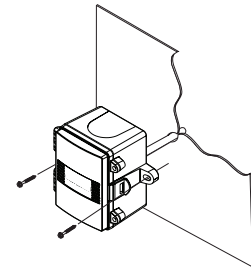

Figure 2

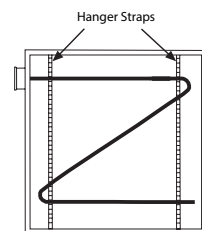

Figure 3

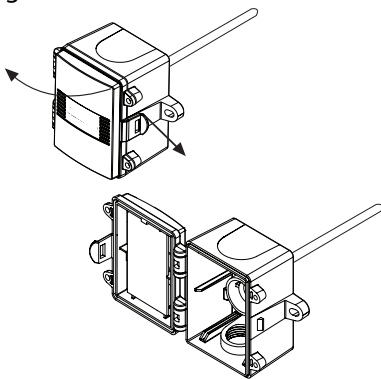

Figure 4

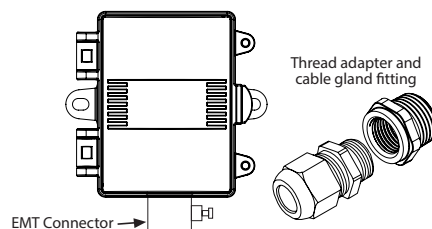
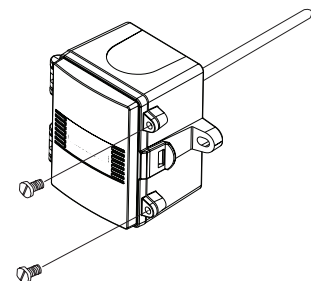
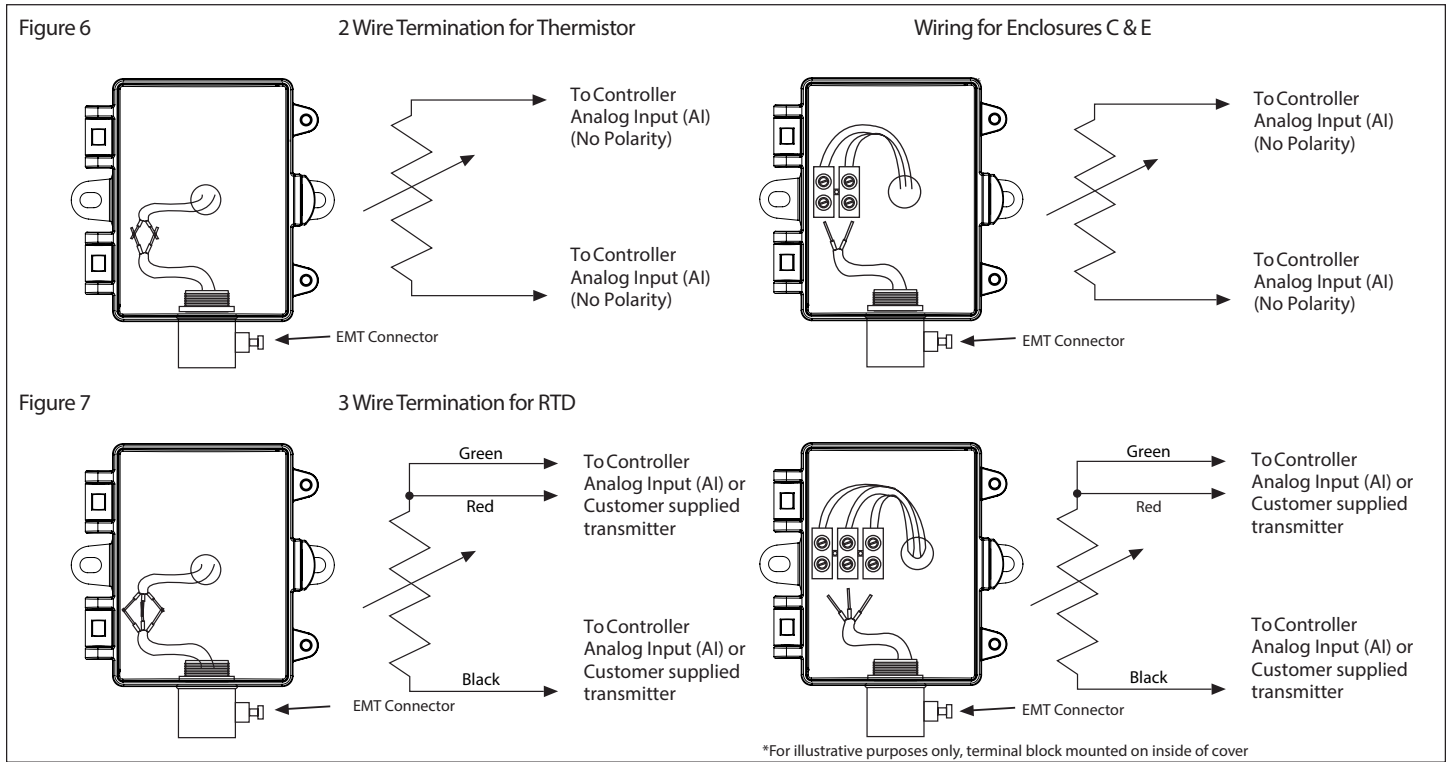

Figure 5



## WIRING

- Use 18-24 AWG shielded wiring for all connections. Do not locate the device wires in the same conduit with wiring used to supply inductive loads such as motors. Make all connections in accordance with national and local codes.
- Pull at least six inches of wire into the enclosure, then complete the wiring connection according to the wiring diagrams below.
- Thermistors are a 2 wire hook up and are not polarity sensitive. See Figure 6.
- RTD's are a 3 wire hook up. See Figure 7.



## TYPICAL WIRE RESISTANCE VALUES

When using low resistance sensors, long wire runs can add significant error to the readings. Use the following chart to determine errors due to wire resistance or consider using a 1000 ohm sensor or a transmitter for better accuracy. Locate the type of wire being used. Multiply the total length of the wire (distance from the controller to the sensor and back) by the number found in the chart below for total resistance.

GAUGE WIRE TYPE	18 AWG	22 AWG	24 AWG
STRANDED (OHMS/FOOT)	5.85 mΩ	14.75 mΩ	23.29 mΩ
SOLID (OHMS/FOOT)	6.4 mΩ	15.85 mΩ	25.72 mΩ

**NOTE:** The sensor accuracies listed in the specifications section apply to the sensing element only prior to product assembly and may not be reflected in the complete assembly.

Due to the measurement uncertainty, it is possible, that the true resistance value of the single delivered sensor at 0°C can be out of the defined tolerance class. Profiling each assembly to take into consideration lead wire and the attachment method should be completed.

## DIMENSIONS

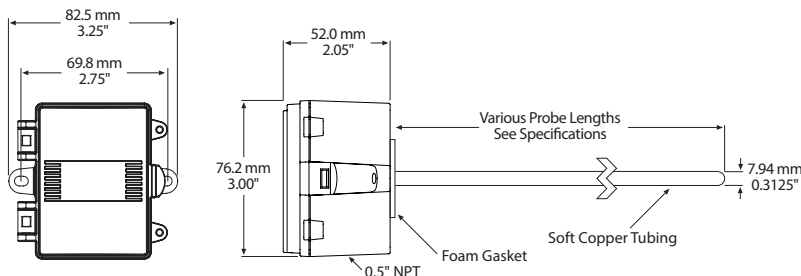

## SPECIFICATIONS:

Sensor Type:..... Various thermistors or RTD  
 Sensor Accuracy:..... **RTD Class A:**  $\pm 0.15^{\circ}\text{C}$  ( $\pm 0.27^{\circ}\text{F}$ ) @  $0^{\circ}\text{C}$  ( $32^{\circ}\text{F}$ )  
**RTD 1/3 DIN:**  $\pm 0.1^{\circ}\text{C}$  ( $\pm 0.18^{\circ}\text{F}$ ) @  $0^{\circ}\text{C}$  ( $32^{\circ}\text{F}$ )  
**RTD 1/10 DIN:**  $\pm 0.03^{\circ}\text{C}$  ( $\pm 0.054^{\circ}\text{F}$ ) @  $0^{\circ}\text{C}$  ( $32^{\circ}\text{F}$ )  
**NTC Thermistor Type 39:**  $\pm 0.05^{\circ}\text{C}$  ( $\pm 0.09^{\circ}\text{F}$ ),  
 0 to  $70^{\circ}\text{C}$  (32 to  $158^{\circ}\text{F}$ )  
**NTC Thermistor Type 55:**  $\pm 0.03^{\circ}\text{C}$  ( $\pm 0.054^{\circ}\text{F}$ ),  
 0 to  $70^{\circ}\text{C}$  (32 to  $158^{\circ}\text{F}$ )  
**NTC Thermistor Type 40/46:**  $\pm 0.1^{\circ}\text{C}$  ( $\pm 0.18^{\circ}\text{F}$ ),  
 0 to  $70^{\circ}\text{C}$  (32 to  $158^{\circ}\text{F}$ )  
 Probe Sensing Range:.....  $-20$  to  $60^{\circ}\text{C}$  ( $-4$  to  $140^{\circ}\text{F}$ )  
 Ambient Operating Range:.....  $-40$  to  $50^{\circ}\text{C}$  ( $-40$  to  $122^{\circ}\text{F}$ )  
 Wire Material:..... FT-6 rated plenum cable, 22 AWG  
 Probe Material:..... Soft Copper  
 Probe Diameter:..... 7.94 mm (0.3125")  
 Standard lengths: ..... 1800, 3600, 6100, 7300 mm (6', 12', 20', 24')  
 Enclosure:..... **A:** UL94-V0, IP65 (NEMA4X)  
**C:** Same as A, with terminal block  
**E:** Same as C, with thread adapter (1/2" NPT to M16), cable gland fitting, and terminal block  
 Termination: ..... **A:** Pigtail, 2 or 3 wire  
**C & E:** Terminal block, 2 or 3 wire  
 Country of Origin:..... Canada