

ANALOG RELAY MODULE

Installation Instructions

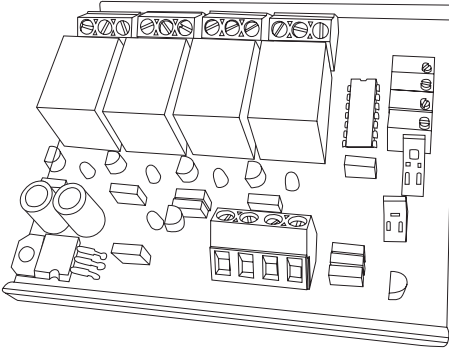

INTRODUCTION

The analog relay module accepts an analog voltage or current signal and controls four output relays. The input signal has three jumper selectable ranges for either 0-7.5 Vdc, 0-15 Vdc, or 0-20 mA. Each relay has an independently adjustable set-point which is set with a multi-turn trim pot.

Each form-C relay activates when the input signal is equal to the trip set-point and deactivates when the input signal falls below the set-point by a deadband amount. The deadband is also jumper selectable for 1, 3, or 5% of the range.

Features include a regulated power output that can be used to power a transducer or a resistance input, top-adjust trim-pots for set-point adjustment, an LED power indicator, status LEDs for each relay and 10 Amp form-C relays. The product comes with standard snap-track for easy mounting.

BEFORE INSTALLATION

Read these instructions carefully before installing and commissioning the device. Failure to follow these instructions may result in product damage. Do not use in an explosive or hazardous environment, with combustible or flammable gases, as a safety emergency stop device or in any other application where failure of the product could result in personal injury. **Take electrostatic discharge precautions during installation and do not exceed the device ratings.**

MOUNTING

The snap-track device may be mounted in any position. Use only fingers to remove the PCB from the snap-track, do not pry on the PCB with tools. Do not flex the PCB during removal or installation. Slide the PCB out of the snap-track or push against one side of the snap-track and lift the PCB out. Ensure any metallic mounting hardware does not contact the underside of the PCB.

Avoid mounting in areas where the device is exposed to vibrations or rapid temperature changes. Mount the snap track with the PCB removed using two screws as shown in Figure 2.

Once the snap track is mounted, place the bottom edge of the PCB into the bottom slot on the snap track and then gently press the top edge in both corners until the PCB snaps into the top slot of the snap track. See Figure 3.

Figure 1

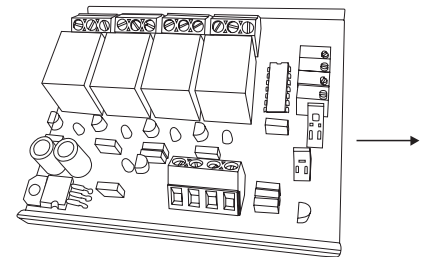

Figure 2

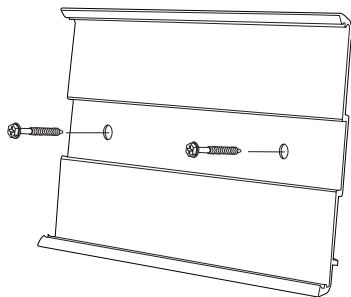
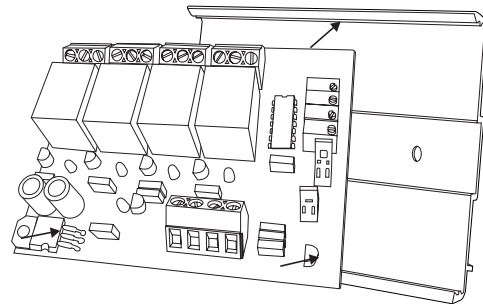

Figure 3



WIRING

- Deactivate the 24 Vac power supply until all connections are made to the device to prevent electrical shock or equipment damage. Follow proper electrostatic discharge handling procedures when installing the device or equipment damage may occur.
- Use 22 AWG shielded wiring for all connections and do not locate the device wires in the same conduit with wiring used to supply inductive loads such as motors. Make all connections in accordance with national and local codes.
- Connect the plus DC or AC voltage hot side to the PWR terminal. The supply common is connected to the COM terminal. The supply common is connected to the COM terminal. The device is reverse voltage protected and will not operate if connected backwards. It has half-wave power supply so the supply common is the same as the input signal common.
- Several devices may be connected to one power supply and the output signals all share the same common. Use caution when grounding the secondary of a transformer or when wiring multiple devices to ensure the ground point is the same on all devices and the controller.
- Ensure the supplied power is within the device ratings. Power supply voltages outside the ratings may cause over-heating, device damage or unreliable operation.
- The analog input signal is connected to the IN terminal and the COM terminal.
- The 20V terminal is a regulated power supply output which provides a 30 Vdc power supply at 30 mA maximum that can be used to operate an external sensor, for example.
- The relay contacts are labeled R1 to R4 to match the set-point pots and each relay has both a normally open and normally closed contact. Ensure the load is within the contact specifications.

Figure 4

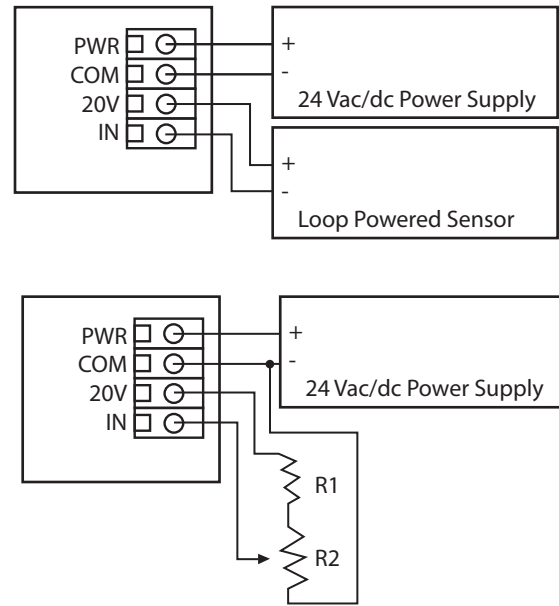
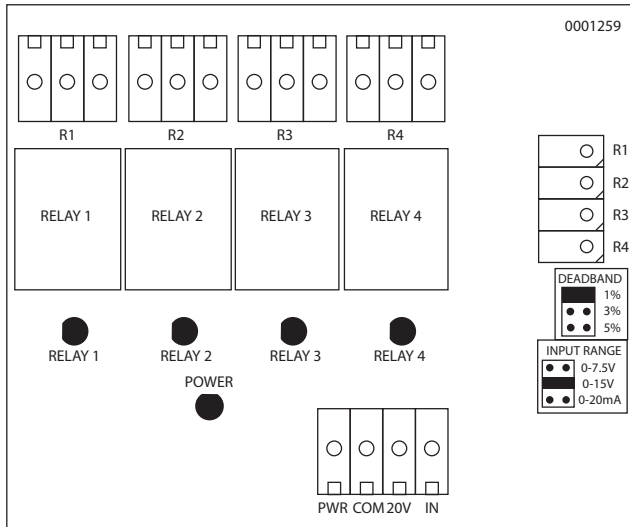

FACTORY CONFIGURATIONS

The device preset is as follows:

- Range is 0-15 Vdc
- R1 is set to 3 Vdc
- R2 is set to 6 Vdc
- R3 is set to 9 Vdc
- R4 is set to 12 Vdc
- Deadband is set to 3%

CALIBRATION AND SETUP

- Set the INPUT RANGE jumper to the correct position for the signal to be used. For example, if the input signal is 2-10 Vdc, select the 0-15 Vdc range.
- Set the deadband jumper to the desired value. This can be changed at any time with the power on.
- Connect the power supply and the input signal to the correct terminals.
- Turn the power on and the POWER LED will light.
- Apply an input signal equal to the R1 set-point.
- Adjust the R1 pot clockwise until the RELAY1 LED goes out, then slowly adjust the R1 pot counter-clockwise until the LED lights.
- Apply an input signal equal to the R2 set-point and adjust the R2 pot the same as for R1, watching the RELAY2 LED.
- Adjust R3 and R4 using the same method.
- Test the operation by increasing the input signal and watch as R1 to R4 turn on at the selected set-points. Then decrease the signal and watch as the relays turn off at the selected set-points minus the deadband.

Figure 6

Input Range	Deadband Values		
	1%	2%	3%
0- 7.5 Vdc	0.075 Vdc	0.225 Vdc	0.375 Vdc
0 - 15 Vdc	0.15 Vdc	0.45 Vdc	0.75 Vdc
0 - 20 mA	0.2 mA	0.6 mA	1 mA

SPECIFICATIONS

POWER OUTPUT

Regulated Power Output.....20 Vdc \pm 10% @ 30 mA max to power an external sensor

INPUT SIGNAL

Input Voltage Range.....0 to 7.5 or 0 to 15 Vdc
 Input Voltage Impedance.....>15 K Ω
 Input Current Range.....0 to 20 mA
 Input Current Impedance.....250 Ω

OUTPUT RELAYS

Type.....SPDT Form C
 Contact Rating.....10 Amps at 125 Vac
 Contact Resistance.....100 m Ω maximum
 Electrical Life.....100,000 operations
 Mechanical Life.....10,000,000 operations

GENERAL

Power Supply.....23 to 30 Vdc, 22 to 27 Vac
 Consumption.....110 mA maximum at 24 Vdc
 Protection Circuitry.....Reverse voltage protected, overvoltage protected
 Operating Conditions.....0 to 50°C (32 to 122°F),
 5 to 95 %RH non-condensing
 Storage Conditions.....-30 to 70°C (-22 to 158°F),
 5 to 95 %RH non-condensing
 Wiring Connections.....Screw terminal block (12 to 24 AWG)
 Enclosure.....Snap track mounting standard,
 99mm L x 82.5mm W 32mm H (3.9" x 3.25" x 1.25")
 Weight.....144gm (5.08oz)
 Country of Origin.....Canada

DIMENSIONS

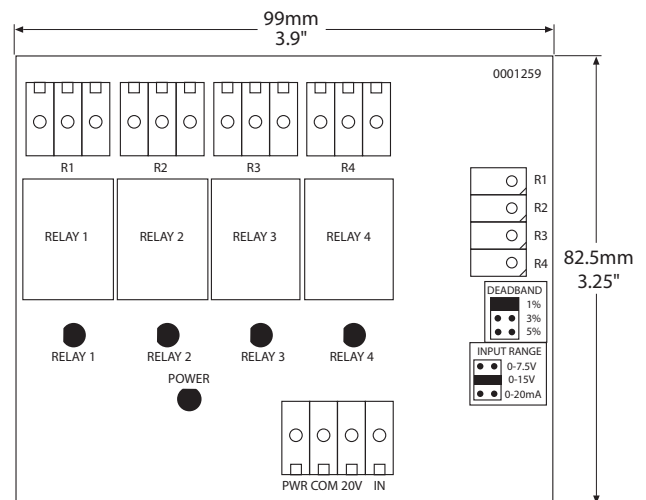

PRINTED IN CANADA