

### INTRODUCTION

In recent years, indoor air quality has been equated to CO<sub>2</sub> levels for Demand Controlled Ventilation (DCV) applications in an effort to improve building health and reduce energy costs. The benefits of healthy and "green" buildings are well known today and progress in controlling ventilation rates to optimum values is still being made. One area that has received significant study and attention is the measurement of indoor air quality pollutants.

The traditional measurement of CO<sub>2</sub> levels is often seen as limiting when compared to the total amount of volatile organic compounds (VOCs) present in the air that have a detrimental effect on the human perception

of air quality. These indoor VOCs are hydrocarbons that originate mainly from bio-effluents (odors from human respiration, perspiration and metabolism) and vapors generated from building materials and

Figure 1

TYPICAL INDOOR AIR VOC CONTAMINANTS		
Contamination Source	Emission Source	VOCs
HUMAN BEING	Breath Skin Respiration and Perspiration Flatus Cosmetics Household Supplies Combustion	Acetone, Ethanol, Isoprene Nonanal, Decanal, α-Pinene Methane, Hydrogen Limonene, Eucalyptol Alcohols, Esters, Limonene Unburnt Hydrocarbons
OFFICE EQUIPMENT BUILDING MATERIAL FURNITURE CONSUMER PRODUCTS	Printers, Copiers, Computers Paint, Adhesive, Solvent, Carpet PVC (Poly Vinyl Chloride)	Benzene, Styrene, Phenole Formaldehyde, Alkanes, Aldehydes, Ketones Toluene, Xylene, Decane

furnishings. There are thousands of unique VOCs that may be present in indoor air that affect the air quality. The table above (Figure 1) lists some of the more common VOCs and their source.

It is generally understood that the root cause of indoor air quality problems lies with the presence of these VOCs. Unfortunately, it has been difficult to accurately measure VOCs due to the lack of suitable VOC sensing devices. Early VOC sensors suffered from long-term stability problems, drift and an output signal that was difficult to define and apply in a reliable way.

CO<sub>2</sub> sensors have long served as an adequate air quality indicator with a defined range ppm output signal that is easy to set thresholds to. The American Society of Heating, Refrigeration and Air-Conditioning Engineers (ASHRAE) Standard 62.1 (Ventilation for Acceptable Indoor Air Quality) is generally used in DCV applications because minimum ventilation rates are clearly defined based on occupancy and CO<sub>2</sub> sensors are then generally used to determine occupancy.

This system has worked for DCV system designers due to its straight-forward design, predictable results and energy saving results. However, the control of indoor air quality based on CO<sub>2</sub> levels alone is not optimal because it ignores other air contaminants that are often present. Ventilation should react on demand toward all sources of contamination, not only CO<sub>2</sub>.

### THE IAQ SENSOR

The Indoor Air Quality Sensor uses an advanced MEMS metal oxide semiconductor sensor to detect poor air quality. The sensor reacts quickly to detect a broad range of VOCs such as smoke, cooking odors, bio-effluence, outdoor pollutants and from human activities. The sensor captures all VOC emissions that are completely invisible to CO<sub>2</sub> sensors.

Extensive studies and research have shown that there is direct correlation between CO<sub>2</sub> levels and VOC levels and the Air Quality Sensor has been calibrated to provide a "CO<sub>2</sub>-equivalent" ppm measurement value, thereby achieving full compatibility to existing HVAC CO<sub>2</sub> ventilation standards. NOTE: The sensor

does not measure CO<sub>2</sub> levels directly, it measures VOCs and provides a CO<sub>2</sub> equivalent reading. The sensor also includes control algorithms that correct sensor drift and aging and therefore provides a long-term consistent DCV solution while overcoming the deficiencies of CO<sub>2</sub> measurement by detecting the true root-cause of ventilation demand, VOCs. The IAQ sensor emulates the human perception of air quality much more than a CO<sub>2</sub> sensor and even detects odorless, potentially hazardous substances such as carbon monoxide.

The CO<sub>2</sub>-equivalent sensor output value was developed over a period of several years to allow the IAQ sensor to be optimized for Demand Controlled Ventilation applications. The long-term IAQ sensor performance was monitored in various locations including offices, cafeterias, schools, production facilities, apartments and homes in direct comparison to infrared-absorption CO<sub>2</sub> sensors. The data shows consistent results between measured CO<sub>2</sub> values and the IAQ CO<sub>2</sub>-equivalent values and also highlight the poor air quality events detected by the IAQ sensor that the CO<sub>2</sub> sensor misses. A sample chart showing CO<sub>2</sub> measurements vs. IAQ measurements is shown in Figure 2.

Figure 2 CO2 Sensor vs. IAQ Sensor

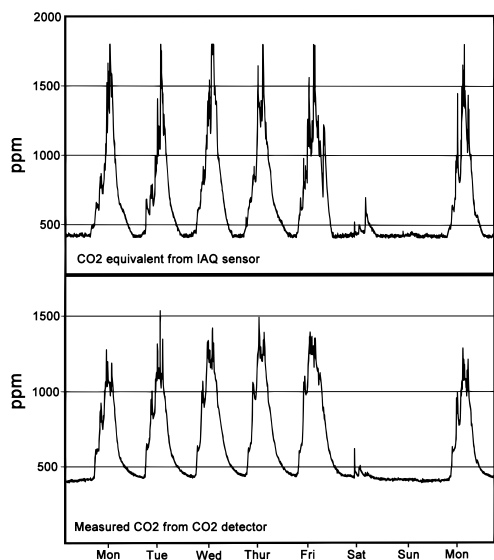

## IAQ SENSOR FEATURES

- Measures total VOCs
- High sensitivity and fast response
- Stable long-term operation
- 0 to 2000 ppm CO<sub>2</sub> equivalent output signal
- LCD to display air quality information
- Internal menu for easy setup
- Analog stepped output for damper control
- Linear output for logging and control
- Selectable 0-5 or 0-10 Vdc signal
- ri-color LED to indicate IAQ level
- Optional relay output with adjustable setpoint
- Optional override switch output
- Optional resistive temperature sensors

## BEFORE INSTALLATION

Read these instructions carefully before installing and commissioning the device. Failure to follow these instructions may result in product damage. Do not use in an explosive or hazardous environment, with combustible or flammable gases, as a safety or emergency stop device or in any other application where failure of the product could result in personal injury. **Take electrostatic discharge precautions during installation and do not exceed the device ratings.**

## MOUNTING

The IAQ room transmitter installs directly on a standard electrical box and should be mounted five feet from the floor of the area to be controlled. Do not mount the sensor near doors, opening windows, supply air diffusers or other known air disturbances. Avoid areas where the detector is exposed to vibrations or rapid temperature changes.

The cover is hooked to the base at the top edge and must be removed from the bottom edge first. Use a small Phillips screwdriver to loosen the security screw as shown in Figure 3. (Complete removal of this screw is not required). Use the screwdriver to carefully pry each bottom corner if necessary. Tip the cover away from the base and sit it aside as shown in Figure 4.

The PCB must be removed from the base to access the mounting holes. Follow usual anti-static procedures when handling the PCB and be careful not to touch the sensors. The PCB is removed by pressing the enclosure base to unsnap the latch near the bottom edge, then the PCB can be lifted out of the base as shown in Figure 4.

Sit the PCB aside until the base is mounted on the wall. For added protection, place the PCB in the supplied anti-static bag.

Figure 3

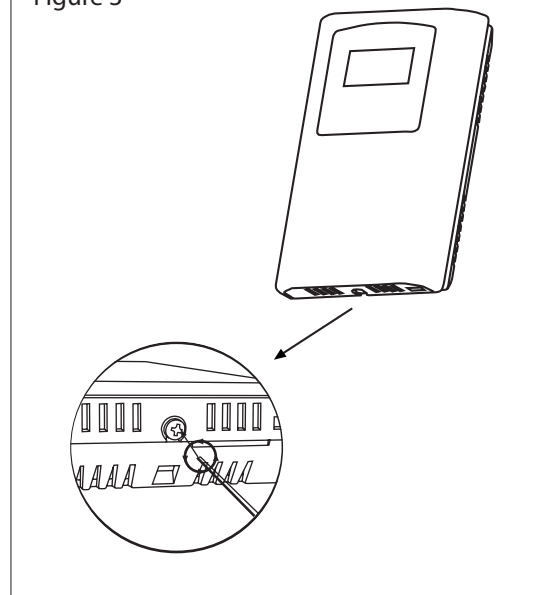

Figure 4

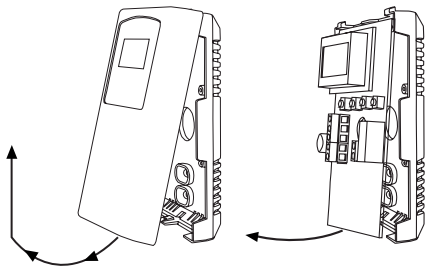
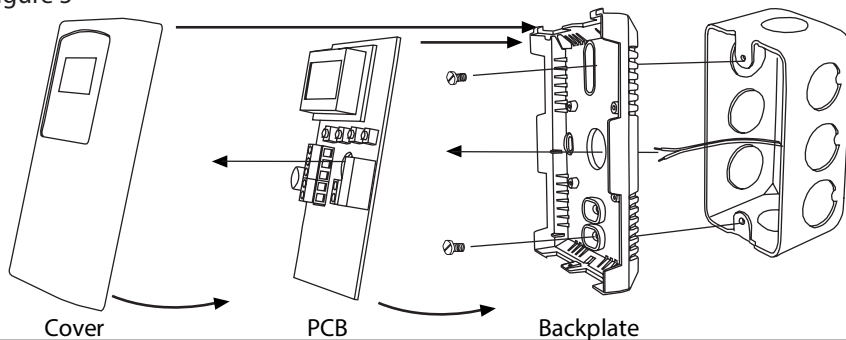

Figure 5



Mount the base by screwing to an electrical box or directly to the wall as shown in Figure 5. The mounting hole locations are shown on page 7.

After the base is screwed to an electrical box or the wall using the appropriate holes, remove the PCB from the anti-static bag, feed connection wires through center hole and place the top of PCB into the PCB holders on backplate and snap bottom of PCB into place as shown in Figure 5.

Make wire connections as per the Wiring Illustrations on Page 3 and install decorative cover by placing the top of the cover into the cover holder on the top of the backplate and snapping the bottom into place as shown in Figure 5. Tighten security screw with a Phillips screwdriver.

Figure 6

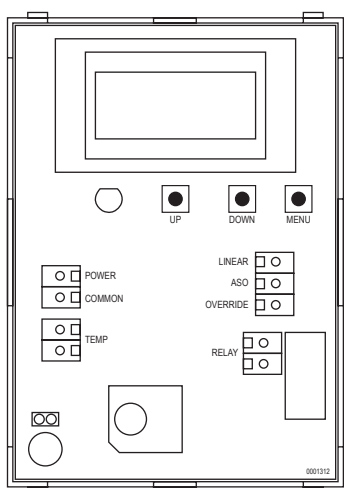

## WIRING

Deactivate the 24 Vac/dc power supply until all connections are made to the device to prevent electrical shock or equipment damage. Follow proper electrostatic discharge (ESD) handling procedures when installing the device or equipment damage may occur.

Use 18-22 AWG shielded wiring for all connections and do not locate the device wires in the same conduit with wiring used to supply inductive loads such as motors. Connect the cable shield to ground at the controller only. Make all connections in accordance with national and local codes.

Connector layout is shown in Figure 6. Diagram shown includes all options. If option is not ordered, connector will not be present.

Connect the positive dc voltage or the hot side of the ac voltage

Figure 7

Typical wiring for 24 Vdc power from controller

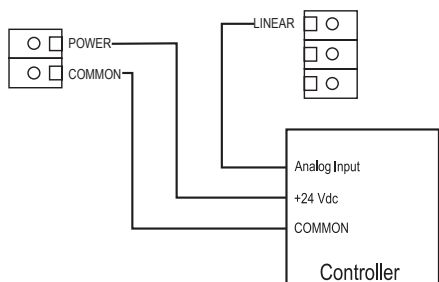

Typical wiring for 24 Vac power transformer

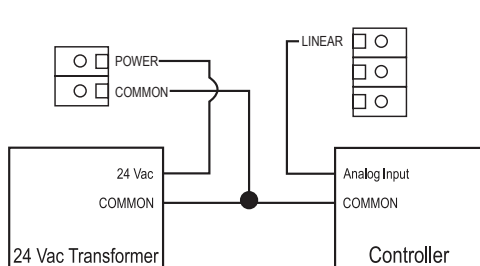

to the terminal marked POWER. The power supply common is connected to the terminal marked COMMON as shown in Figure 7. The device is reverse voltage protected and will not operate if connected backwards. This device has a half-wave type power supply so the power supply common is the same as the output signal common. Therefore, several devices may be connected to one power supply and the output signals all share the same signal common. Use caution when grounding the secondary of an ac transformer or when wiring multiple devices to ensure that the circuit ground point is the same on all devices and the controller.

Figure 8

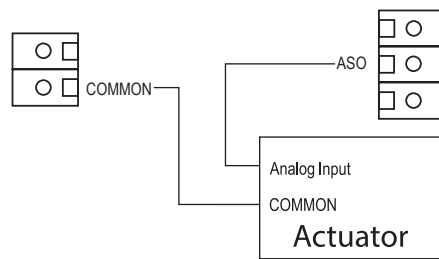

Ensure the controller Analog Input (AI) matches the IAQ voltage output signal type before power is applied. The voltage signals have a minimum load rating. Follow the ratings in the Specification section or inaccurate readings may result.

Figure 9

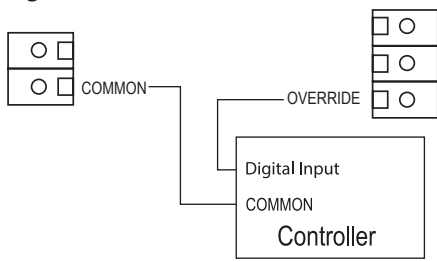

Figure 10

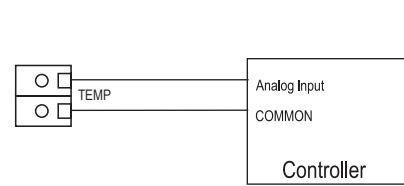
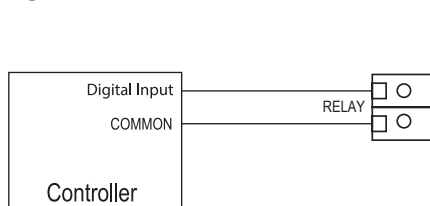

Figure 11



Connect the LINEAR output signal to a 0-5 or 0-10 Vdc analog input port on the controller as shown in Figure 7. The device is factory configured for 0-5 Vdc output signal but may be changed to 0-10 Vdc via the menu. Changing the output signal may be done during set up of the device. This linear output signal represents the 0-2000 ppm CO<sub>2</sub>-equivalent value.

The ASO (Analog Stepped Output) output signal is a second voltage signal that represents the three air quality levels of GOOD, FAIR and POOR. Each level may be set independently via the menu to any value between 0 and 10 Vdc. The factory default is GOOD = 2.5 V, FAIR = 5.0 V and POOR = 7.5 V. This signal can also be connected to a controller analog input, or it can be connected directly to a 0-5 or 0-10 Vdc input of a damper actuator for direct ventilation control as shown in Figure 8. In this way, the Indoor Air Quality Sensor can be used as a stand-alone device. Since all steps are completely adjustable, the device can also drive a reverse acting actuator.

The optional override switch output is a digital output signal that is controlled by the front panel override button. The signal is available on the OVERRIDE terminal and will short the OVERRIDE terminal to COMMON when activated as shown in Figure 9. This signal typically connects to a low voltage digital input of the controller to indicate room occupancy or override when the button is pressed. This output uses a FET to create the pull-down to common so respect the device ratings.

An optional resistive temperature sensor may also be included in the device and is connected to the TEMP terminals as shown in Figure 10. Various thermistors or RTDs may be installed on the pcb to suit the application. These terminal would connect to a thermistor or RTD sensor input on the controller.

Another optional signal is the relay output available on the RELAY terminals. The relay output terminals are completely isolated from other connections and are NOT connected to the signal COMMON terminal as shown in Figure 11. This signal can be used to directly control an alarm, a ventilation fan or may be connected to a digital input of the Building Automation System for status monitoring. Respect the relay contact specification.

## SET-UP

Verify that the Air Quality Sensor is properly wired and all connections are tight. Apply power to the device and note that the LCD will display the software version number for a few seconds and then the device will enter Warm Up mode. The Warm Up mode will last for five minutes and the LCD will count down the time. The status LED will cycle through the three colors (green / red / blue). This time is required to allow the device and sensor to reach normal operating temperature.

After the five minutes has expired the device will enter normal operation and the LCD will indicate the IAQ status and ppm value.

## OPERATION

In normal operation, the Air Quality Sensor will detect a broad range of reducing gases such as CO and VOCs and translate the measurement into a parts per million (ppm) CO<sub>2</sub> equivalent value. This value is displayed on the LCD in either ppm or % as set in the menu. The air quality value is also displayed as either GOOD, FAIR or POOR and these values can also be set via the menu.

The GOOD, FAIR and POOR air quality levels control the Analog Stepped Output (ASO) signal. The ASO output signal comprises of three independently set voltage levels that can be used to directly control a damper actuator for three positions. The levels are set via the menu and each level can be set anywhere from 0-10 Vdc. The GOOD, FAIR and POOR air quality levels will also be displayed on the tri-color front panel LED. The LED colors are displayed as GOOD = green, FAIR = blue and POOR = red. If required, the

LED operation can be disabled via the menu.

The air quality value is also sent to the LINEAR output as a 0-5 or 0-10 Vdc signal to represent the 0-2000 ppm CO<sub>2</sub> equivalent. This signal can interface to any voltage analog input for logging or control purposes.

The linear output scaling and ASO operation is shown below. Note that the ASO GOOD/FAIR trip level = 1000 ppm and the FAIR/POOR trip level = 1500 ppm. The ASO output levels are GOOD = 2.5 V, FAIR = 5.0 V and POOR = 7.5 V.

Linear Output vs. IAQ ppm

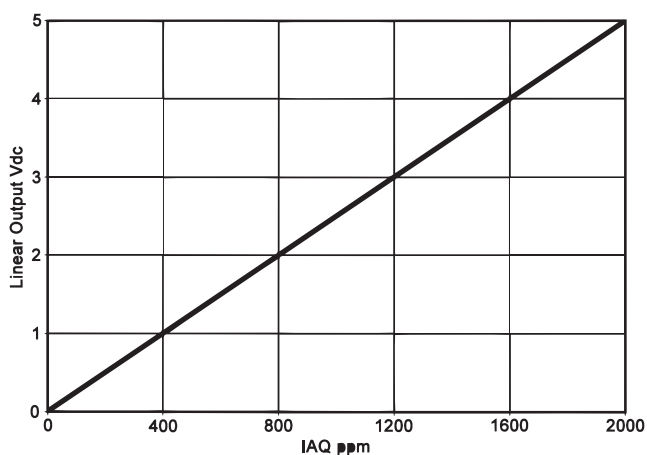

IAQ ppm and ASO Operation

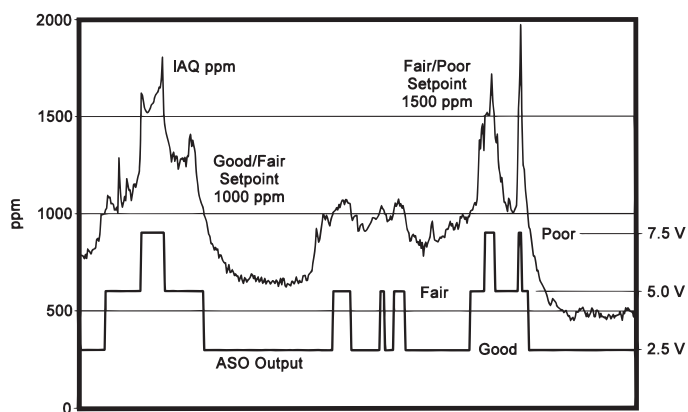

If the device is equipped with the optional relay, then the normally open relay will close when the air quality exceeds a pre-set trip point. The trip point and hysteresis value can be programmed via the menu such that the relay closes when IAQ > Relay Setpoint and opens when IAQ < Relay Setpoint - Hysteresis. By default, the relay has a one minute minimum on and off time to prevent short cycling. This feature may be disabled via the menu. The menu may also be used to test the relay function and change the relay action to normally closed (N.C.). The relay can be used to control an alarm, fan directly or to signal a digital input.

If the device has the optional Override function installed, then a front panel pushbutton can be used to generate an override signal output. The override signal can be configured for either Momentary, Latch or Toggle operation via the menu. This signal can be connected to a digital input of the controller.

Various optional resistive temperature sensors may also be included on the pcb and are available at the TEMP output. This is a two-wire resistive output signal and the temperature value is not displayed on the LCD.

Other features and configuration are described in the Setup Menu section.

**NOTE:** The air quality sensor requires a continuous burn-time of at least 3 weeks before the sensor algorithms provide accurate measurements. During this period the product-to-product readings may show large variations. The sensor may also indicate very high PPM readings during the initial burn-in phase.

The air quality sensor is meant to provide an accurate measurements of INDOOR air quality. Diesel exhaust is not a component of indoor air quality and the sensor should not be used in such an application.

## START-UP

The menu may be accessed any time after the initial warm-up period. The menu is controlled by using the three buttons on the PCB labeled UP, DOWN and MENU. All values entered are saved in non-volatile memory and will be restored correctly in case of a power failure.

The menu has several items as shown below. To enter the menu, press and release the <MENU> key while in normal operation. This will enter the menu step 1, pressing the <MENU> key a second time advances to step 2. Each press of the <MENU> key advances the menu item. The <UP> and <DOWN> keys

are used to make changes to program variables by scrolling through the available options. When a value is changed, use the <MENU> key to save it to memory and advance to the next menu item. Actual menu displays with the factory default values are shown. If no keys are pressed for 2 minutes, the menu will automatically exit.

<MENU> Press and release to enter the SETUP menu

## 1. IAQ UNIT

IAQ Unit  
ppm

The LCD displays the IAQ sensor reading from 450-2000 ppm. Use <UP> or <DOWN> to change from ppm (default) to % for 0-100 % display. 0-100% = 450-2000 ppm. This setting has no effect on the LINEAR output signal, it is always scaled 0-2000 ppm = 0-5/0-10 Vdc.

<MENU> Press to advance to next menu item

## 2. IAQ G/F

IAQ G/F  
1000 ppm

This sets the trip point from Good to Fair IAQ for the LED and ASO. The factory default is 1000 ppm. Use <UP> or <DOWN> to change from 700 to 1200 ppm in 25 ppm steps.

<MENU> Press to advance to next menu item

## 3. IAQ F/P

IAQ F/P  
1500 ppm

This sets the trip point from Fair to Poor IAQ for the LED and ASO. The factory default is 1500 ppm. Use <UP> or <DOWN> to change from 1300 to 1700 ppm in 25 ppm steps. Note that both IAQ trip points have a 25 ppm hysteresis built in.

<MENU> Press to advance to next menu item

## 4. ANALOG OUTPUT

Analog  
Out 5V

The LINEAR analog output signal defaults to 0-5 Vdc. It can be changed with <UP> or <DOWN> to 0-10 Vdc. The selected scale is always equal to 0-2000 ppm.

<MENU> Press to advance to next menu item

## 5. ASO GOOD OUTPUT

ASO Good  
2.5Vdc

This sets the ASO output voltage for the Good range. It can be set using <UP> or <DOWN> anywhere from 0-10 Vdc. Resolution is 0.1 Vdc. The value is shown on the LCD and the ASO output changes accordingly. If connected to a damper actuator, positioning is easy.

<MENU> Press to advance to next menu item

## 6. ASO FAIR OUTPUT

ASO Fair  
5 Vdc

This sets the ASO output voltage for the Fair range. It can be set using <UP> or <DOWN> anywhere from 0-10 Vdc. Resolution is 0.1 Vdc and ASO out updates as above.

<MENU> Press to advance to next menu item

## 7. ASO POOR OUTPUT

ASO Poor  
7.5 Vdc

This sets the ASO output voltage for the Poor range. It can be set using <UP> or <DOWN> anywhere from 0-10 Vdc. Resolution is 0.1 Vdc and ASO out updates as above.

<MENU> Press to advance to next menu item

## 8. BACKLITE ON/OFF

Backlite  
On

The LCD backlight is normally on, it can be turned off here.

<MENU> Press to advance to next menu item

## 9. IAQ CALIBRATION

IAQ Cal  
0 ppm

Use <UP> or <DOWN> to add or subtract an offset to the IAQ signal. This can change from -200 to + 200 ppm in 10 ppm increments.

<MENU> Press to advance to next menu item

Only if **Relay Option** is installed

### 10. RELAY TEST

Relay  
Test OFF

Use <UP> or <DOWN> to toggle the relay contacts on or off for testing.

<MENU> Press to advance to next menu item

### 11. RELAY SETPOINT

Relay SP  
1000 ppm

Use <UP> or <DOWN> to change the relay setpoint from 750-1500 ppm. Default is 1000 ppm. Resolution is 25 ppm.

<MENU> Press to advance to next menu item

### 12. RELAY HYSTERESIS

Relay Hy  
100 ppm

Use <UP> or <DOWN> to change the relay hysteresis to 20, 50, 100 or 200 ppm. Default is 100.

<MENU> Press to advance to next menu item

### 13. RELAY DELAY

RL Delay  
YES

There is a 1 minute minimum on time and a 1 minute minimum off time applied to the relay operation to prevent short cycling. This feature can be disabled here by setting to NO.

<MENU> Press to advance to next menu item

### 14. RELAY ACTION

Relay Op  
NO

The default relay operation is Normally open (relay closes on alarm). It can be changed to NC for Normally Closed operation (relay opens on alarm).

<MENU> Press to advance to next menu item

Only if **Override Option** is installed

### 15. OVERRIDE MODE

Override  
Mode Mom

Use <UP> or <DOWN> to change the Override operating mode from the default Mom (momentary) to either Lat (latch) or Tog (toggle). Momentary means the Override output is only ON while the front panel key is pressed, Latch means the output is ON for 5 seconds after a key press and then it turns OFF again, Toggle means that the output changes state whenever the key is pressed.

<MENU> Press to advance to next menu item

## 16. LED

LED  
On

The LED is normally enabled (On), it can be disabled (Off) here.

<MENU> to exit the User Menu and return to normal operation

# SPECIFICATIONS

- Sensing Technology .....MEMS metal oxide semiconductor VOC sensor
- Measurement Range.....450-2000 ppm CO<sub>2</sub> equivalent or 0-100% (menu selectable)
- Drift Compensation.....Automatic baseline correction
- Power Supply .....20-28 Vac/dc (non-isolated half-wave rectified)
- Consumption .....35 mA max @ 24 Vdc
- Input Voltage Effect.....Negligible over specified operating range
- Protection Circuitry.....Reverse voltage protected, over voltage protected
- Operating Conditions.....0 to 50 °C (32 to 122 °F) 5 to 95 %RH non-condensing
- Linear Output Signal .....0-5 / 0-10 Vdc (menu selectable) = 0-2000 ppm CO<sub>2</sub> equivalent
- Analog Stepped Output Signal ..Three steps representing Good, Fair and Poor air quality  
(each step is independently adjustable from 0-10 Vdc)
- Output Drive Capability.....10 KΩ minimum
- Programming and Selection.....Via internal push-buttons and LCD menu
- Warm-up Time .....5 minutes
- LCD Resolution .....1 ppm / 1 %
- LCD Size .....1.4" w x 0.6" h (35 x 15 mm) alpha-numeric 2 line x 8 characters
- LCD Backlight.....Enable or disable via menu
- LED Display .....Tri-color (Good = Green, Fair = Blue, Poor = Red),  
enable or disable via menu
- Wiring Connections.....Screw terminal blocks (14 to 22 AWG)
- Enclosure .....White ABS, IP30 (NEMA 1)
- Dimensions .....84 w x 119 h x 29 d mm (3.3"w x 4.7"h x 1.15"d)
- Weight.....122 gm (4.3 oz)
- Optional Override Switch.....Front panel switch with FET output, 30 Vdc @ 50 mA max
- Optional Relay Output .....Form A contact (N.O. or N.C.) 2 Amps @ 140 Vac, 2 Amps @ 30 Vdc  
(Relay action, trip point and hysteresis set via menu)
- Optional Temperature Sensor ....Various thermistors and RTDs, 2-wire resistive output
- Country of Origin.....Canada

# DIMENSIONS

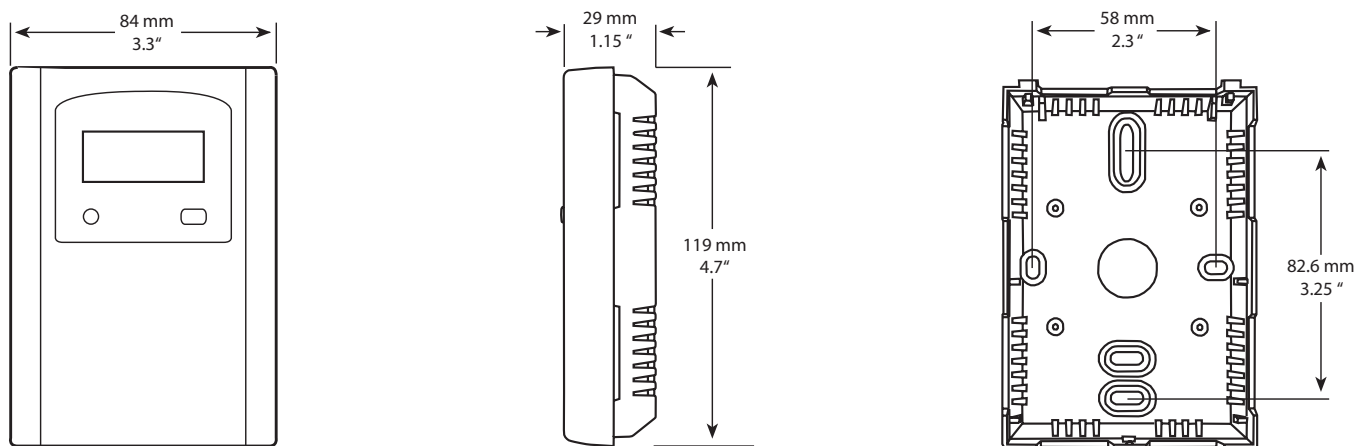

PRINTED IN CANADA